

21 PB

SECRET



No

34

50X1

ECONOMIC INTELLIGENCE REPORT

CIVIL DEFENSE IN THE USSR



CIA/RR 84
30 November 1956

CENTRAL INTELLIGENCE AGENCY

OFFICE OF RESEARCH AND REPORTS

50X1



SECRET

7-23-1964

W A R N I N G

This material contains information affecting the National Defense of the United States within the meaning of the espionage laws, Title 18, USC, Secs. 793 and 794, the transmission or revelation of which in any manner to an unauthorized person is prohibited by law.

S-E-C-R-E-T



50X1

ECONOMIC INTELLIGENCE REPORT

CIVIL DEFENSE IN THE USSR

CIA/RR 84

(ORR Project 41.1627)

CENTRAL INTELLIGENCE AGENCY

Office of Research and Reports



50X1

S-E-C-R-E-T

S-E-C-R-E-T

FOREWORD

Section VI of this report, on the medical aspects of civil defense in the USSR, was contributed by the Medicine Division of the Office of Scientific Intelligence. The information in Section VIII, on civil defense against nuclear weapons, was coordinated with the Nuclear Energy Division of the Office of Scientific Intelligence.

50X1

- iii -

S-E-C-R-E-T

S-E-C-R-E-T

CONTENTS

	<u>Page</u>
Summary	1
I. Organization	5
A. Air Defense	5
B. Liability for Civil Defense Service	5
C. MPVO Service of the MVD	6
D. Cities or Rayons	7
1. Fire Defense Service	8
2. Emergency Engineering Service	8
3. Medical Service	9
4. Service for Sanitary Processing of Personnel and Decontamination of Clothing	9
5. Service for Decontamination of Areas and Structures	9
6. Service for Maintenance of Order and Security	10
7. Warning and Communications Service	10
8. Shelter and Cover Service	10
9. Blackout Service	10
10. Veterinary Service	11
11. Evacuation Service	11
12. Transport Service	11
E. MPVO Rayons	12
F. Industrial Targets (<u>Ob"yekty</u>)	12
G. Self-Defense Groups	13
II. Voluntary Society for Cooperation with the Army, Air Force, and Navy (DOSAAF)	13
A. Aims	13
B. History of Paramilitary Societies	14
C. Current Pressure on DOSAAF	15
D. Membership	17
E. Organization	17

S-E-C-R-E-T

	<u>Page</u>
F. Financing and Supply	19
III. Plans and Training	20
A. Security	20
B. Personnel	20
C. Plans	21
D. Training	21
1. Technical Facilities Identified with the MPVO	22
2. PVKhO Schools	22
3. Factory Training	23
4. Training in Schools and Universities	23
5. DOSAAF Training Program	24
6. Drills	25
7. Training of MPVO Formations	25
E. Behavior Instructions	26
1. "Threatening Situation"	26
2. Air Alarm	26
3. Gas Alarm	27
4. All Clear	27
IV. Air-Raid Shelters	27
V. Other Related Activities	35
A. Police	35
B. Fire Defense	35
1. Organization	35
2. Civil Defense and Fire Fighting	36
3. Auxiliary Water Supplies	37
4. Fire Prevention	38
5. Development of Reinforced Concrete Construction	39

S-E-C-R-E-T

	<u>Page</u>
C. Supplies	39
1. In <u>Ob'yekty</u> and Institutions	39
2. MPVO and MVD	40
3. DOSAAF	40
4. In Apartment Dwellings	40
5. Stockpiling	41
D. Communications	41
E. Motor Transport	42
F. Chemical Defense	42
G. Blackout	44
VI. Medical Aspects of Civil Defense	44
A. Resources	44
B. Organization and Functions of MPVO Medical and Veterinary Services	45
1. Medical Service	45
a. Missions and Functions	47
b. Use of Facilities	51
2. Veterinary Service	56
C. Defense Against Special Weapons	57
1. Chemical Warfare	57
a. Nerve Gases	57
b. MSS MPVO Decontamination Measures	58
2. Biological Warfare	59
a. Detection and Identification	60
b. Decontamination	61
c. Prevention and Therapy	61
3. Nuclear Warfare	62

S-E-C-R-E-T

	<u>Page</u>
VII. Chronology of Civil Defense in the USSR	62
A. 1948	63
b. 1949-50	63
C. 1951-52	63
D. 1953-54	64
E. 1955-56	65
VIII. Civil Defense Against Nuclear Weapons	65
IX. Civil Defense in the European Satellites	69
A. Albania	69
B. Bulgaria	69
C. Czechoslovakia	70
D. East Germany	72
E. Hungary	74
F. Poland	75
G. Rumania	77
X. Possible Action to Retain Control Under Air Attack	79
A. Suggested Modified Plan	80
1. Before D Day (Possibly Two Weeks)	80
2. Shortly Before Attack (H Hour Minus 8)	80
3. Upon Release of Soviet Attack (D Day, H Hour)	81
4. At Time of "Air Alert" (H Plus 2?)	81
B. Composition of Civil Defense Units	82
1. Order Crews	82
2. Communications Crews	82
3. Repair Crews	82
4. Fire-Fighting Crews	83
5. Medical and Veterinary Crews	83
6. Antichemical and Antiatomic Crews	83
7. Plant Disaster Crews	83
C. Advantages of the Suggested Plan	84

S-E-C-R-E-T

Appendixes

	<u>Page</u>
Appendix A. Chronology of Some Civil Defense Developments in the USSR, 1948-56 . . .	87

50X1

Illustrations

	<u>Following Page</u>
Figure 1. Organization of Civil Defense in the USSR (Chart)	6
Figure 2. Organization of the Voluntary Society for Cooperation with the Army, Air Force, and Navy (DOSAAF) in the USSR (Chart)	18
Figure 3. Sketches of Apartment Air-Raid Shelters in the USSR	28
Figure 4. Sketches of Soviet Gas Filters	30
Figure 5. Sketch of an Apartment Air-Raid Shelter near Kiev, USSR	30
Figure 6. Steel Bulkhead Doors for Basement Air- Raid Shelters, Prague, Czechoslovakia (Photograph)	30
Figure 7. Sketches of Apartment Air-Raid Shelters, Stalingrad and Stalino, USSR	30

S-E-C-R-E-T

S-E-C-R-E-T

Following Page

Figure 8.	Sketch of a Detached Air-Raid Shelter, Stalino, USSR	32
Figure 9.	Sketch of a Soviet Detached Air-Raid Shelter	32
Figure 10.	Sketches of Soviet Heavy Air-Raid Shelters	34
Figure 11.	Sketch of a Filter Ventilating System for a Soviet Air-Raid Shelter	34
Figure 12.	Compartmentized Basement Air-Raid Shelter, Kiev, USSR (Photograph)	34
Figure 13.	Sketch of a Soviet Portable M-600 Fire Pump	38
Figure 14.	Sketch of a Supposed Air-Raid Siren, Moscow, USSR	42
Figure 15.	Sketches of Soviet Decontamination Equipment	44
Figure 16.	Sketch of a Soviet Chamber Flame and Spark Arrester	44
Figure 17.	Organization of Medical Civil Defense in the USSR (Chart)	46
Figure 18.	Organization of MPVO Emergency Medical Treatment of Mass Casualties in the USSR (Chart)	48
Figure 19.	Operation of Soviet Blood Transfusion Services in Disaster and Wartime Situations (Chart)	52
Figure 20.	Operational Chain of Command of Soviet Medical Civil Defense at a Target (Chart)	54

- x -

S-E-C-R-E-T

S-E-C-R-E-T

Following Page

50X1



Figure 22. Basement Air-Raid Shelter under Construction, Czechoslovakia (Photograph)	72
Figure 23. Entrance to a Reported Air-Raid Shelter, Brno, Czechoslovakia (Photograph) . .	72
Figure 24. Bunker-Type Air-Raid Shelter, Constanta, Rumania (Photograph)	78

S-E-C-R-E-T

CIA/RR 84
(ORR Project 41.1627)

S-E-C-R-E-T

CIVIL DEFENSE IN THE USSR*

Summary

The USSR has an extensive, widely organized civil defense system. Since 1949, increased pressure has been evident to improve its organization, to undertake defensive construction, and to increase training. An integral part of over-all Soviet Anti-Air Defense (PVO), civil defense is the responsibility of the Main Administration of Local Anti-Air Defense (GUMPVO), an arm of the Ministry of Internal Affairs (MVD). Under GUMPVO is a body of civil defense staff officers who are assigned to posts at all levels of government. Local Anti-Air Defense (MPVO) officers are also present in many major enterprises, supervising civil defense preparations in factories, ports, railroad centers, and other economic installations.

The Soviet system provides for both specialized training for civil defense personnel and personal training for the average citizen. GUMPVO maintains a Central Scientific Laboratory and a medical experimental installation. Undoubtedly, these installations develop techniques and materials for civil defense.

The Voluntary Society for Cooperation with the Army, Air Force, and Navy (DOSAAF) is the organization charged with giving Anti-Air and Chemical Defense (PVKhO) training to its members and to the general population. Its membership may be over 20 million at the present time. Most of its members are probably under compulsory enrollment in the PVKhO training course, which embraces general knowledge of civil defense, including alarm signals, types of attack, gas defense and decontamination, first aid, atomic and biological defense instruction, and fire-control measures. DOSAAF organizations are formed in factories, institutions, collective and state farms, machine tractor stations, schools, and dwelling units.

* The estimates and conclusions contained in this report represent the best judgment of ORR as of 1 September 1956.

S-E-C-R-E-T

S-E-C-R-E-T

First-aid training is conducted by the Red Cross and Red Crescent Societies. Persons who complete the course and pass an examination are awarded the badge "Ready for Sanitary Defense" (GSO). Members of these societies would be extensively used as auxiliary personnel for medical organizations which have civil defense roles.

By 1949 the USSR had initiated a program of shelter construction which probably was set up to include air-raid shelters and other civil defense measures in the initial construction of public buildings, factories, schools, and apartment dwellings. Reports of returning prisoners of war who worked on such construction indicate that the inclusion of air-raid shelters in new buildings is standard practice in such widely scattered areas as Khabarovsk, the central Urals, Stalingrad, and several cities in the Ukraine. Most of these reports describe shelters as having sufficient strength to withstand the complete collapse of buildings. The shelters, designed to be gasproof, are fitted with double, hermetically sealed doors. Provision was made for filter ventilating systems, but most reports do not reflect installation of these systems, either because such systems were to be installed later by Soviet workers or because installation has been deferred to a later date. The construction of such shelters is continuing at the present time, and the population has been advised that they are satisfactory protection against atomic weapons. A 1956 publication and the available information on shelter-building activities in the European Satellites show that heavier underground shelters and hillside galleries have been designed, and it must be presumed that some have been constructed for the use of various headquarters and government officials.

The fact that urban and industrial fire-fighting forces are subordinate to the MVD should facilitate their integration into the MPVO system. Fire prevention has been stressed in the USSR, and the new emphasis on concrete construction should gradually reduce vulnerability to fire. The prevalence of wooden construction, however, is still a menace in urban areas.

Civil defense preparation in the USSR has increased since 1948. Basic radiofication of the country, which is useful in disseminating air alarms, was ordered in 1949. Training for civil defense began in 1949-50, with emphasis on the preparation of instructors. The years from 1950 to 1952 were marked by construction of basement-type air-raid shelters, by the publication of at least three civil defense manuals, and by the formation of DOSAAF from existing paramilitary

- 2 -

S-E-C-R-E-T

S-E-C-R-E-T

societies. Some civil defense training was already carried out by DOSAAF, and in 1952 PVKhO study circles were made mandatory in all primary units. In 1953 a new chairman was put in charge of DOSAAF, and a heavy recruiting drive began, amounting to compulsion for Komsomol members to join. PVKhO training became compulsory for all DOSAAF members. In 1954 the guarded release of information on atomic warfare to troops in open publications was begun. According to an announcement issued after an unusual plenary session of DOSAAF, the provision of modern air defense training for the whole population was made a high-priority goal of DOSAAF. Civil defense activity reached a high level in 1955 and 1956, when the need for improved civil defense was stressed publicly by Soviet leaders, a concerted drive was begun for modification of the civil defense organization, and training was instituted for defense against atomic and bacteriological weapons.

Some firm conclusions and others which border on speculation may be drawn from Soviet preparations for civil defense. Foremost among the firm conclusions is that the leaders of the USSR have initiated a widespread and presumably costly effort to develop civil defense in the Soviet Bloc. Whether the initiation of this effort is inspired by actual fear of attack from the West or by a Soviet intention to initiate war cannot be determined at present. In either event, the widespread and developing civil defense system improves the defensive attitude of the USSR and the European Satellites, even though it may be not entirely adequate against the larger nuclear weapons. The Soviet willingness to devote great effort and considerable sums of money to civil defense is shown by the training of millions of people and by a widespread program of shelter construction. The development of civil defense in this relationship is facilitated by central direction and planning, by financing of construction which must be supplied or ordered by the central government, and by compulsory enrollment and training of personnel. The dictatorial control structure of the USSR would probably be an advantage in emergency situations when the habit of unquestioning obedience to authority may insure the maintenance of discipline.

The second firm conclusion about Soviet civil defense is that until 1954 it was directed against attack with high explosives rather than with atomic weapons. Also, chemical defense instructions did not mention nerve gases, and defense against biological warfare agents was not publicized. At the present time, both antiatomic and biological aspects of civil defense are being accented, and retraining and reorganization

- 3 -

S-E-C-R-E-T

S-E-C-R-E-T

are apparently going on. The general population, however, still must rely on relatively inadequate local shelters for protection from aerial weapons. Some heavy and suburban shelters have undoubtedly been prepared, but these are not believed to be adequate for more than selected control elements of the government. The fact that evacuation or dispersal of the general population has not been publicly mentioned in the USSR is not conclusive evidence that no plans along this line are being prepared. If the USSR adopted a policy of evacuation, the civil defense staff, closely allied with the extensive nationwide police structure, would greatly facilitate its execution. The millions of DOSAAF members, who have had military and civil defense training, would be available for duty as auxiliary control personnel.

It seems possible to conclude also that Soviet military planners have recognized that heavy aerial attack is the most serious military threat to the continuation of the Communist regime. This is shown by the simultaneous pursuit of the civil defense program, the development of nuclear weapons, and the improvement of aerial offensive and defensive capabilities.

The structure of civil defense in the European Satellites as well as their civil defense training and related measures indicates that the Soviet pattern is being closely followed. Substantial progress has been made since 1950, particularly in Bulgaria, Hungary, and Czechoslovakia, and recently increased civil defense activity has become apparent in Poland, Rumania, and East Germany.

The comparatively recent initiation of civil defense measures in East Germany, including a defensive construction program, could be interpreted as reflecting the intention to keep Germany divided. This conclusion is reinforced by other steps which have been taken to rearm East Germany and establish it as a separate national entity.

S-E-C-R-E-T

I. Organization.*

A. Air Defense.

Air defense -- or, more precisely, anti-air defense (Protivo-vozdushnaya Oborona -- PVO) -- is the name given in the USSR to all measures for combating air attack, for denying the enemy opportunity to attack, and for diminishing the consequences of air attack. 1/** It includes the Air Warning and Observation Service (Vozdushnoye Nablyudeniye Oповeshcheniye i Svyaz' -- VNOS); antiaircraft artillery (zenitnaya artilleriya -- ZA); antiaircraft machineguns (zenitnyy pulemet -- ZPl) and small arms; combat by fighter aviation (istrebitel'-naya aviatsiya -- IA); use of barrage balloons (aerostat zagrazhdeniya -- AZ) and antiaircraft searchlights (zenitnyy prozhektor -- ZPr); engineering measures (shelter), camouflage, and the dispersal and maneuver of troops and ships; and the disorientation and deception of the enemy. Local Anti-Air Defense (Mestnaya Protivovozdushnaya Oborona -- MPVO) organizations also participate in the PVO of the country. Active air defense is the responsibility of the Anti-Air Defense of the Country (PVO Strany), a separate organization under the Ministry of Defense. 2/ The Commander-in-Chief for PVO Strany is probably a deputy minister. 3/ Civil defense is coordinated with or monitored by PVO Strany, and when a city or region is under attack, the PVO commander, if one is present, takes over the operational control of civil defense. 4/

Published objectives of the MPVO include the timely warning of the population of the danger of air attack, the maximum possible protection of the population and physical assets from the effects of any weapon, the assurance of timely medical assistance for casualties, and the prompt reduction of damage resulting from attack. 5/

B. Liability for Civil Defense Service.

The defense of the homeland is the responsibility of all citizens of the USSR. Soviet propaganda has referred to "every Soviet citizen's sacred duty to defend the socialist motherland." 6/ It has been indicated that this duty includes not only support of the armed forces but also participation in paramilitary activities, sports, and civil defense. 7/ During World War II the "sacred duty" of the Soviet

* For the organization of civil defense in the USSR, see Figure 1, following p. 6.

50X1

S-E-C-R-E-T

citizen was reinforced by a law making able-bodied citizens aged 16 to 60 liable to serve in civil defense assignments. 8/ The repeal of this law has not been reported.

C. MPVO Service of the MVD.

The central body of the Soviet civil defense system is a staff corps of specialized personnel known as the MPVO. This body is under the Ministry of Internal Affairs (Ministerstvo Vnutrennykh Del -- MVD), USSR, and is administered from Moscow by the MVD Main Administration of Local Anti-Air Defense (Glavnoye Upravleniye Mestnoy Protivovozdushnoy Oborony -- GUMPVO).

GUMPVO supervises civil defense plans and assists the Council of Ministers, USSR, in developing civil defense policy, cooperating closely with PVO Strany. Its functions include the design and development of civil defense installations and equipment and the development of civil defense techniques. For the latter functions it maintains a Central Scientific Research Laboratory and probably other institutions in various regions. 9/ A medical experimental plant for civil defense is known to be located in Odessa. 10/ GUMPVO also establishes Tables of Organization and Equipment for all civil defense organizations. 11/

Subordinate to GUMPVO are the republic Administrations of Local Anti-Air Defense (Upravleniye Mestnoy Protivovozdushnoy Oborony -- UMPVO). 12/ Subordinate MPVO offices are located in oblasts, rayons, and cities. Republic and rayon MPVO organizations provide some specialized training but have limited supervisory functions, at least in peacetime. Under the headquarters for MPVO in a city (Shtab MPVO) are the regional MPVO offices if the city is divided into rayons. 13/

In addition to the national and local offices of the MPVO, there are MPVO inspectors assigned to important industrial plants and transportation installations. 14/ These inspectors or chief inspectors must assure that civil defense is properly prepared. MPVO inspectors in an enterprise are subordinate to the military mobilization office in the plant and ultimately to the Mobilization Department of the ministry concerned. 15/

Both the PVO authorities and the MPVO have roles in the approval of new construction. It is known that the MPVO takes part in the peacetime function of town planning. 16/ PVO has been reported

ORGANIZATION OF CIVIL DEFENSE IN THE USSR

Figure 1

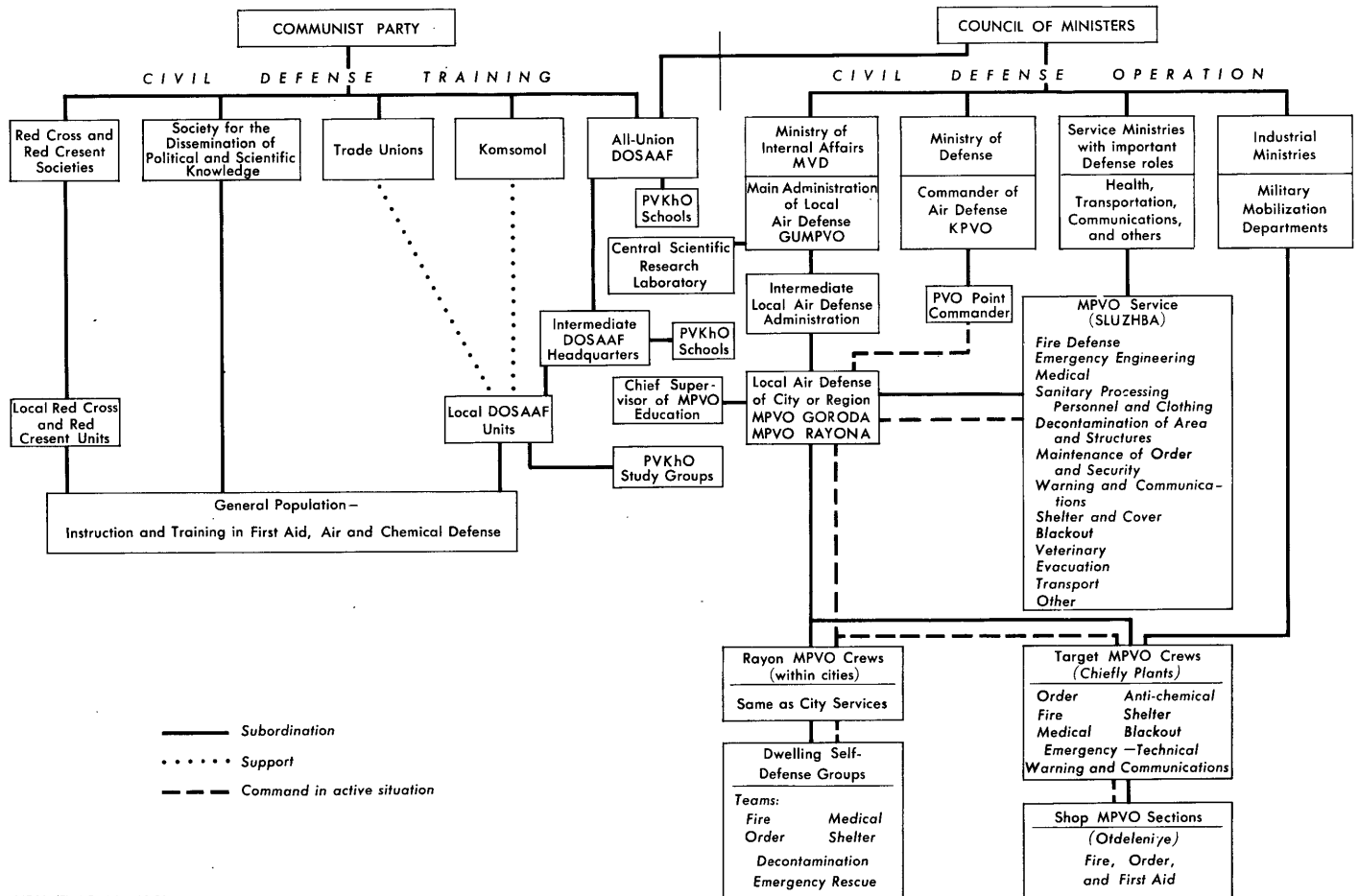

S-E-C-R-E-T

to be the organization which issues permits for new industrial sites, with MPVO having the power to review plans. 17/ These functions are probably closely coordinated. Reportedly, each architectural planning trust employs an air defense specialist, 18/ and MVD officers (probably of the MPVO) have been observed inspecting basement air-raid shelters in new buildings. 19/ These measures enable air defense and civil defense authorities to influence the dispersion of plants and the provision of air-raid facilities in new construction.

The MPVO corps thus appears to be composed of staff and planning personnel at all levels of government, a research staff, inspectors for local air defense in important enterprises, and monitors for construction.

D. Cities or Rayons.*

The basic operational unit of civil defense is the city or rayon organization. All departments of the city or rayon must be integrated into local air defense. Technical facilities of public property and industry must be widely used, and air defense is to be carried out by local governmental and Party bodies, enterprises, public organizations, and large numbers of workers.

The responsibility for civil defense rests nominally with the Council of Workers Deputies of the city. The chairman of its Executive Committee is the Chief of MPVO in the city. He organizes, prepares, and directs the system through an organization known as the MPVO staff. 20/ Although the Soviet of Workers Deputies still exercises some control, 21/ it has been confirmed that MPVO officers of the MVD and their headquarters at the city and rayon (within the city) levels are actually responsible for civil defense preparations. 22/

It has been reported that the headquarters of an MPVO battalion were moved in 1952 from Leningrad to Tallinn, 23/ where the battalion was to be responsible for organizing local air defense measures for the city. There is nothing, however, to indicate that this battalion is

* Information on this structure is based on World War II instruction manuals, confirming references in DOSAAF (see II, pp. 13 ff., below) civil defense manuals published since 1950 and in a few reports. It should be noted that these are instructions and plans supplemented by little observation of implementation, possibly because of security restrictions rather than lack of plans or activity.

S-E-C-R-E-T

more than a skeleton staff of civil defense specialists whose organizations are made up of men from local groups. [redacted] the Tallinn civil defense organization includes a colonel in charge of the city headquarters and four captains who command rayon civil defense offices. A central training school for civil defense in Tallinn is staffed by an MVD captain, another officer assistant, a storekeeper, and civilian instructors. 24/

50X1
50X1

The civil defense responsibilities of the Chief of MPVO in the city and his staff include the following: (1) formulating plans, (2) training staffs and units, (3) organizing and mobilizing crews and detachments for local air defense, (4) organizing training programs for specialized personnel as well as for the general population, (5) preparing and coordinating a financial and materials procurement plan, and (6) supervising all these activities through timely controls. In the event of an air raid, the Chief of MPVO and his staff are to direct the forces and facilities of the city in the elimination of the effects of the attack. 25/

In exercising these responsibilities the MPVO of a city organizes and controls the following services, whose responsibilities are as indicated below 26/:

1. Fire Defense Service.

The basic forces for the fire defense service include professional fire companies, volunteer fire brigades, civil defense fire-fighting organizations in industrial and service installations, and fire-fighting squads of self-defense groups. This service is responsible for carrying out fire preventive measures, insuring the presence of fire-fighting equipment and signals, and supervising sector and self-defense fire-fighting groups. According to a 1956 manual, instruction includes methods of extinguishing fires under difficulty (in the presence of obstacles and radioactive contamination and in the absence of normal water supplies).

2. Emergency Engineering Service.

The basic forces for the emergency engineering service include formations made up of personnel of municipal services and road construction organizations. This service is charged with taking preventive measures to avert the interruption of basic services in the community and with repairing them rapidly in the event of damage.

S-E-C-R-E-T

(It is assumed that these include electrical, water, gas, and sewer systems, and the like, as well as the road network and public transportation.) The 1956 manual states in discussing the mission of this service that all MPVO personnel and able-bodied citizens will assist in rescue work.

3. Medical Service.

The medical service includes the regular medical organization and the civil defense auxiliaries organized and trained in large part through the efforts of the Red Cross and Red Crescent Societies. In time of emergency this service administers all medical establishments (permanent and temporary) and their adaptation to civil defense, registers and supplies all medical materials, directs planning and training for medical personnel, and supervises first-aid training for the general population. In time of emergency it directs all medical and medical evacuation measures and carries out observation and quarantine measures, as well as the sanitary processing of casualties contaminated with toxic agents, radioactive substances, or disease-producing microbes and toxins. 27/

4. Service for Sanitary Processing of Personnel and Decontamination of Clothing.

The service for sanitary processing of personnel and decontamination of clothing is probably organized chiefly in public baths -- instructions call for the preparation of municipal service enterprises. This service is charged with acquiring and storing necessary materials, making ready suitable buildings, and training a cadre of workers. In time of emergency it is organized to process people and clothing affected by poison gas, radioactive substances, or bacteriological agents. This and the following service are closely coordinated with and probably are supervised by the medical command of the Medical Service.

5. Service for Decontamination of Areas and Structures.

The service for decontamination of areas and structures is charged with acquiring materials, training a cadre of personnel, and adapting local equipment for the decontamination of structures and areas. In emergencies it locates, records, and presumably marks off areas contaminated with poisonous, radioactive, or biological warfare agents and performs the necessary decontamination.

S-E-C-R-E-T

6. Service for Maintenance of Order and Security.

The service for the maintenance of order and security uses regular militia and auxiliaries. Its responsibilities include the enforcement of quarantine, the enforcement of public order, traffic direction, blocking off dangerous areas, and supervision of blackout. It enforces rules of conduct, fights panic, and safeguards public property.

7. Warning and Communications Service.

The warning and communications service is responsible for preparing and keeping in constant readiness the necessary warning system. It is also responsible for providing the civil defense system with reliable communications for operational situations. It trains personnel for operation of the system and organizes crews for quick repair of communications. In large cities, separate services for communications and for warning may be organized.

8. Shelter and Cover* Service.

The shelter and cover service is charged with providing the population with necessary shelters and covers. It prepares plans for construction and obtains the government authorization necessary for converting suitable basements and building new air-raid shelters and covers. It trains civil defense groups in shelter maintenance. The service prepares maps of existing shelters so that they can be quickly located in debris after an attack. Its personnel are to be trained in rescue work.

9. Blackout Service.

The blackout service is charged with the preparation of a blackout plan, the accumulation of blackout material, and the accomplishment of blackout preparations. Its preparation includes provision for cutting off street lights centrally and educating the general population.

* The term shelter includes masonry construction of a permanent type, equipped with a filter ventilating system. A cover is a protective structure assembled from prefabricated parts or locally available materials and without a filter ventilating system. In this report, slit trenches and other temporary measures are also referred to as covers.

S-E-C-R-E-T

10. Veterinary Service.

The veterinary service prepares for the protection of animals and their treatment in case of injury. Its functions include the protection and decontamination of food, water, and equipment for animals from chemical, radioactive, and bacteriological agents.

11. Evacuation Service.

The evacuation service, which is not listed in a 1956 civil defense manual, was formerly responsible for the transportation of persons and property from the stricken areas and for their quartering. (Mass emergency evacuation has been neither reported nor mentioned in Soviet civil defense literature.)

12. Transport Service.

The transport service also is not among those listed in a 1956 manual. Its functions were to keep the MPVO advised about traffic routes and to adapt equipment for civil defense tasks such as transporting casualties and carrying out decontamination, training drivers for operations under air raid conditions, and controlling all forms of transportation.

The omission of the latter two services from a 1956 civil defense manual is not considered evidence that the functions have ceased to exist. Certainly the use of atomic weapons would produce homeless persons and would result in heavy demands for emergency housing and transportation. It is believed that both the evacuation and transport functions must still be included in civil defense planning. The Soviet paramilitary society, which is closely allied with the civil defense system, is certainly carrying on intensified driver training. It seems possible that this society, in cooperation with the military authorities, may have relieved the MPVO structure of the operation of a transportation-evacuation scheme.

In addition to the services listed above, others may be added in large cities or under special conditions.

Normally the chief of the city service involved is the head of the organization forming the nucleus of the comparable civil defense service. For example, the senior medical officer would head the medical service, the fire chief the fire-fighting service, and the militia commander the order and security service.

S-E-C-R-E-T

E. MPVO Rayons.

Within large city MPVO organizations are found rayon commands and their crews. 28/ The crews are similar in mission and title to the city services and are charged with operations within their area, subject to the directives of the city or rayon staff. It is possible that they are the larger operating units of the civil defense system. The instructions make the city services "responsible," but the rayon crews "must" carry out such measures as fire fighting, reporting, and decontamination. 29/

50X1
50X1
50X1

Operational civil defense rayon crews would logically be emphasized if drills on a sector basis were to be realistic. The rayon level of organization is also mentioned in a 1956 instruction manual for civil defense. 31/

F. Industrial Targets (Ob"yekty).

Production enterprises, ports, railroad junctions and stations, powerplants, and other establishments of great economic or defense importance are considered MPVO targets (ob"yekty) and have their own MPVO organizations. 32/ The mission of the MPVO body within a target is to assure the uninterrupted production or functioning of the enterprise under air attack, including the preservation of the physical plant, personnel, and stock and the rapid elimination of damage after the attack.

Although the manager of an enterprise is nominally the Chief of MPVO, presumably the operative head is a Chief of Staff or Inspector of MPVO, who must have had special training in civil defense. 33/ The MPVO of a plant is subordinate both to the military mobilization department of the ministry concerned and to the MPVO of the city or rayon. 34/ In tactical matters of civil defense the MPVO of a plant is subordinate to the city or rayon staff of MPVO. 35/ Within the plant, services are formed with responsibilities for such functions as communications and warning, order and security, fire fighting, decontamination, shelter, medical service, and repairs. Because larger plants normally have their own guard and fire-fighting forces, the reinforcement and training of the order and security crews and the fire-fighting crews are simplified. Personnel of the existing plant dispensaries or hospitals are the nuclei for the medical crews. In addition to the services, there are shop crews, organized under the shop manager, for

- 12 -

S-E-C-R-E-T

S-E-C-R-E-T

decontamination, fire fighting, medical service, and order and security. The repair of damage to plants and the salvaging of materials is a universal responsibility.

G. Self-Defense Groups.

According to DOSAAF publications, 36/ the local air defense of dwellings, small institutions, schools, and farms is to be accomplished by the formation of self-defense groups, which are formed in each dwelling unit housing 300 or more people. Large apartment blocks may have several groups organized for each 500 to 700 persons. Where dwellings house less than 300 people, groups are formed cooperatively with those of other buildings.

Self-defense groups consist of a small staff (chief, assistant chief for political work, property manager, and messenger) plus six teams. One team of six men is to maintain order and observation and is charged with giving warning of an impending air and gas attack, enforcing blackout regulations, maintaining order, and protecting property. The fire-fighting team of seven men is responsible for fire fighting, looking after its own fire-fighting equipment, and aiding fire brigades when necessary. A 6-man damage control and rescue team does simple repairs to utilities and assists in rescuing people trapped by collapsed buildings, and a 5-man medical team is responsible for first aid and for the evacuation of casualties needing further treatment. The five-man shelter team, organized when the building has organic shelter, is charged with maintenance of the shelter and sending residents to it during an alert, and the commander of the shelter team is the commandant of the shelter. Any citizen over 16 years of age may be required to serve in self-defense groups except those having civil defense assignments with other MPVO groups.

II. Voluntary Society for Cooperation with the Army, Air Force, and Navy (DOSAAF).

A. Aims.

The second important organization concerned with passive air defense in the USSR is the Voluntary Society for Cooperation with the Army, Air Force, and Navy (Dobrovol'noye Obshchestvo Sodeystviya Armii Aviatsii i Flotu -- DOSAAF). According to its bylaws, DOSAAF is a "mass organization of the workers of the USSR, established on a voluntary basis with the aim of strengthening the Soviet Army, Air

S-E-C-R-E-T

Force, and Navy." The tasks of the society are to disseminate military information among its members as well as to the general population and to prepare them for all types of air and chemical defense. ^{37/} The latter mission has been reaffirmed in a front-page editorial in Pravda which stated that within DOSAAF "priority must be given to the preparation of all the population for modern air and chemical defense." ^{38/}

Civil defense training is by no means the entire mission of DOSAAF. Its members are also encouraged to acquire a military skill in such fields as skiing, marksmanship, flying, parachute jumping, gliding, amateur radio technique, automobile driver training, motor-cycling, horsemanship, the construction of model airplanes and ships, and the breeding of service dogs.* ^{39/} These activities are extensively publicized and undoubtedly furnish the major incentive for youth to join DOSAAF.

B. History of Paramilitary Societies.

Paramilitary effort on the part of the USSR dates back to the period immediately following the Revolution of 1917. The Society for the Promotion of Defense and Aero-Chemical Development (Obshchestvo Sodeystviya Oborone i Aviatsionno-Khimicheskomu Stroitel'stvu -- OSOAVIAKhIM), which was the DOSAAF-type organization during World War II, had antecedents reaching back to the Military Scientific Society of 1920. OSOAVIAKhIM, whose main purpose as stated in Bol'shaya sovetskaya entsiklopediya, 1947, was the preparation of reserves for the armed forces of the USSR, claimed to have successfully trained over 38 million citizens in air and chemical defense before the outbreak of World War II. This training included anti-aircraft and antichemical measures, fire fighting, and first aid. By the end of the war, OSOAVIAKhIM reportedly had trained 98 million people in civil defense measures. Like its successor, DOSAAF, this World War II organization also gave paramilitary training -- many of its members served with distinction in partisan and Soviet Army units. ^{40/} After the war, interest in OSOAVIAKhIM apparently slackened, and it was divided into three societies: the Voluntary Society for Cooperation with Aviation (Dobrovol'noye Obshchestvo Sodeystviya Aviatsii -- DOSAV), the Voluntary Society for Cooperation with the Army (Dobrovol'noye Obshchestvo Sodeystviya Armii -- DOSARM), and the Voluntary Society for Cooperation with the Navy (Dobrovol'noye Obshchestvo Sodeystviya Flotu -- DOSFLOT). These

* DOSAAF has the responsibility for breeding service dogs.

S-E-C-R-E-T

three societies either failed to improve defense work or were considered inadequate for some future task, and they were consolidated into one organization, DOSAAF, in the fall of 1951. ^{41/} The work of DOSAAF was carried on during 1951-53 by an Organizational Committee under the chairmanship of Colonel General V.I. Kuznetsov, although the bylaws of DOSAAF provided for the All-Union Conference to be the highest governing organ. A press recruitment campaign, the general tenor of which was highly critical, was carried on from February to May 1953. ^{42/} Low membership, insufficient guidance, nonpayment of dues, and the low level of training were criticized. Following this criticism a new chairman of DOSAAF was appointed. ^{43/} He was Lieutenant General Nikolay F. Gritchyn, of whom little is known except that he served as an antiaircraft artillery officer during World War II. The appointment of a former air defense commander as the head of DOSAAF could be interpreted as placing an increased emphasis on air defense.

C. Current Pressure on DOSAAF.

In October and November 1953 the DOSAAF Organizational Committee published in the society's monthly organ, Voyennyye znaniya, two extremely critical articles on the state of work. ^{44/} The new administration found that membership had increased "only" 48.3 percent in the 2 years since the beginning of DOSAAF. This figure, however, was questionable because of neglected records and even deliberate falsification. An inspection of records was ordered, and severe punishment was threatened in cases of deceit or falsification. Additional criticism was aimed at the low level of participation, the poor recruitment system for instructors, and the poor state of supply and sports activity. To encourage membership and participation in DOSAAF activity, an extensive press and radio campaign was initiated culminating in the first All-Union Conference of DOSAAF in Moscow, which ended on 29 December 1953. It appears that DOSAAF was able to enlist increased support from other public bodies, particularly from the All-Union Lenin's Young Communist League (Vsesoyuznyy Leninskiy Kommunisticheskiy Soyuz Molodezhi -- VLKSM, or Komsomol). Although the bylaws of the Komsomol obligated its members to devote time to military study, its members had not been enthusiastic about fulfilling this obligation by entering DOSAAF activity. ^{45/} Pressure on Komsomol members during 1951-52 had apparently been unable to overcome this inertia. During this period, phrases in the Soviet press included such statements as "enlist Komsomol members," they "ought to pioneer in mass military ...

S-E-C-R-E-T

activities," and the Komsomol was "urged" to participate in active DOSAAF work. 46/ Following the appointment of Gritchkin, however, the tone changed. In January 1954 a Komsomol kray conference "ordered" its members to improve mass defense work in cooperation with DOSAAF organizations. 47/ Trade unions also were warned sharply in the newspaper Trud that they were "obliged to achieve the setting up of primary organizations of DOSAAF in every enterprise, in every institution and establishment of learning, in every state farm and machine tractor station." 48/ In October 1953, Komsomol committees and committees of DOSAAF began holding joint meetings. 49/

50X1

[redacted] in 1954 urban Komsomols were participating 100 percent in DOSAAF and that 60 percent of the 1,600 workers in the port of Tallinn had been enrolled in DOSAAF, the younger ones more or less by force. In addition, 90 percent of the port workers had been given short courses in PVKhO measures. [redacted]

50X1

50X1
50X1

[redacted] A
Tass transmission of 9 October 1954, for example, claimed that 8,000 new primary DOSAAF organizations were set up in the first 6 months of 1954. 51/

Another indication of continued pressure on DOSAAF occurred in July 1954 when a plenary session of the Central Committee of DOSAAF was called, only 7 months after the first All-Union Conference. (The DOSAAF bylaws require only that the plenary session be held at yearly intervals between conferences.) Chairmen of republic, kray, and oblast DOSAAF committees were called into the session. It was announced that the subjects for discussion were as follows: (1) the state of work and measures for its improvement, (2) an examination of auditing, and (3) the holding of report and election meetings near the end of 1954. 52/ Evidently other things were discussed and other people were present, because Komsomol'skaya pravda announced on 7 August 1954 that the Central Committee of the Komsomol and the Central Committee of DOSAAF had jointly decided to hold a spartakiada (sports competition), with the first round beginning on 1 August. Compulsory events were to include marksmanship, marching, grenade throwing, and a PVKhO competition, as well as a fifth optional event.

- 16 -

S-E-C-R-E-T

S-E-C-R-E-T

During 1955, pressure to enlarge DOSAAF and improve its activities continued. Another new commander appeared -- Guards Colonel General P.A. Belov, a cavalry officer with an impressive combat record as commander of the 61st Army. Since the war he has served as a military district commander in the North Caucasus and in the southern Urals. 53/ Belov has repeatedly stressed the necessity for DOSAAF to utilize demobilized reserve officers and soldiers for leadership and instruction. 54/

The DOSAAF activities which were keynoted during 1956 have been the modification of civil defense training to include measures against bacteriological and atomic weapons 55/ and the assignment of responsibility to DOSAAF for organizing as well as training the self-defense groups. 56/

D. Membership.

The size of the membership of DOSAAF has not been announced and is a subject for speculation. OSOAVIAKhIM, the direct antecedent of DOSAAF, had an announced membership of 15.5 million on 1 January 1947. 57/ Membership in DOSAAF in 1952 is estimated to have been 16 million. 58/ Membership drives accompanied the election and accountability campaigns of 1953 and 1954, and there have probably been substantial gains since then. The new measures to gain recruits from the Komsomol and trade unions have been noted above -- total Komsomol membership has been announced as 18,852,327. 59/ The low age limit (14) of DOSAAF makes it probable that some Young Pioneers (Yunyy Pioner -- YuP) have also been recruited. On 3 November 1953 it was stated that DOSAAF had a "membership of millions," 60/ and on 2 March 1954 the chairman of DOSAAF used the term "many millions" and indicated continuing growth. 61/ On 31 August 1954, Pravda stated that DOSAAF was one of the largest mass public organizations in the USSR. In view of the size of the membership of its predecessor; the manpower resources of the Communist Party, the Komsomol, the trade unions, and others; the evident pressure for enlistment; and the guarded satisfaction expressed, DOSAAF membership is probably between 20 million and 25 million at the present time.

E. Organization.*

According to its bylaws, the highest governing organ of DOSAAF is the All-Union Conference, which meets every 4 years. The Conference

* For the organization of DOSAAF, see Figure 2, following p. 18.

S-E-C-R-E-T

decides important questions determining the society's course of action and confirms and makes all necessary changes in the society's bylaws. The All-Union Conference elects its executive organs, the Central Committee and the Central Auditing Commission.

The DOSAAF bylaws state that in the period between All-Union Conferences the Central Committee assumes leadership of the society. Elected for a 4-year term, the Central Committee holds a plenary session at least once a year. It represents DOSAAF at all state and public functions; supervises DOSAAF clubs, schools, technical laboratories, and other institutions; and establishes particular work programs. It elects a Presidium, which consists of a chairman, deputies, and other members and which is responsible for the daily leadership of the society. Decisions of the Central Committee and its Presidium are binding on all DOSAAF organizations and members.

The DOSAAF bylaws also provide for the establishment of DOSAAF organizations and committees on the union and autonomous republic, kray, okrug, oblast, city, and rayon levels. Autonomous republic, kray, oblast, city, and rayon conferences are held not less than once every 2 years, and their respective committees and auditing commissions are elected for a 2-year term. DOSAAF committees in the union republics are required to hold a plenary session at least once a year and to elect a Presidium. 62/

Primary organizations of DOSAAF may be set up in all enterprises and institutions, kolkhozes, factories, and schools where there are at least three members of the society. It was announced by the DOSAAF chairman on 4 November 1953 that "almost every factory, office, collective or state farm, and school has its own DOSAAF group." 63/ It was also stated that the formation of DOSAAF primary organizations in dwellings was another principal task. 64/ In large primary organizations of more than 100 members, subordinate organizations may be formed having the rights of primary organizations.

A meeting of members of a primary organization must be held at least once every 3 months. In order to conduct the business of a primary organization with 15 or more members, a committee is elected at the general meeting for a 1-year term. The number of members on the committee is determined by the general meeting, and a chairman, deputy chairman, and treasurer are elected.

ORGANIZATION OF THE VOLUNTARY SOCIETY FOR COOPERATION WITH THE ARMY, AIR FORCE, AND NAVY (DOSAAF) IN THE USSR

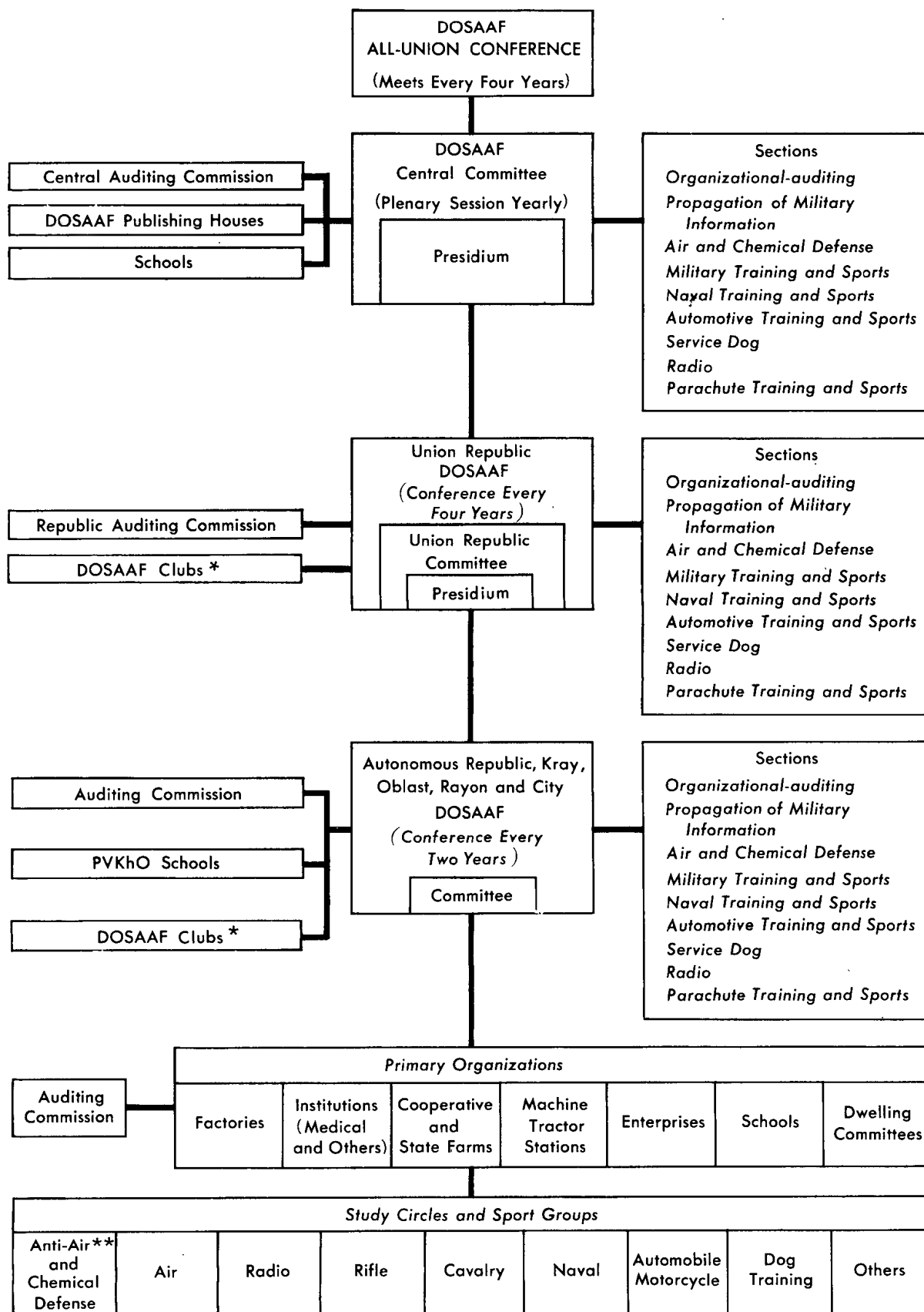

* Advanced activities for those who have exhausted facilities of groups and circles of primary organizations.
 ** Compulsory in all primary organizations.

S-E-C-R-E-T

Primary organizations with 15 or more members also elect an auditing commission for a 1-year term. This commission is responsible for the inspection of expenditures and the collection of dues, for the maintenance of training appliances and premises, and for the recording of membership and the minutes of meetings. In primary organizations with less than 15 members, an inspector is elected.

The DOSAAF bylaws provide for the creation of sections under committees of the All-Union, union republic, kray, okrug, oblast, city, rayon, and other large primary organizations. These sections help the committees work out questions pertaining to training, military-sport, and propaganda work and are useful in helping to review and correct activities of primary organizations and to eliminate equipment shortages. Recommended and announced sections include the following: organizational-auditing; propagation of military, military-technical, air, and naval information; PVKhO; military training and sports; naval training and sports; air training and sports; automotive training and sports; service dog; parachute; and radio. 65/

DOSAAF clubs are formed at city, rayon, oblast, and republic levels to provide advanced activities for those who have exhausted the facilities of primary organizations. 66/

DOSAAF membership is open to all citizens of the USSR, women as well as men, who have reached the age of 14. Members are accepted into the society on written application, and the question of admission is decided either by the committee of the primary organization or by a general meeting of the primary organization where there is no such committee. Only members who have reached the age of 18 may be elected to leadership positions, except in primary organizations of secondary schools, factory and plant schools (shkoly fabrichno-zavodskogo obucheniya -- FZO), and the like, where members under 18 years of age may be elected.

F. Financing and Supply.

The financing of DOSAAF is complex, and many of its aspects are unknown. The monetary funds of the organization consist of initiation fees, membership dues, funds allocated by public organizations and institutions concerned with the development of the society's activity, and "other" receipts. Funds are spent by the primary organization committee for training needs in accordance with

S-E-C-R-E-T

estimates made by the general meeting. DOSAAF members pay a membership fee of 3 rubles a year, either in 1 or 2 installments. Members of secondary, trade, railroad, and FZO schools as well as housewives pay dues of 1 ruble a year. There is an initiation fee of 1 ruble plus a fee for the cost of the application blank.

Other sources of financial aid as well as contributions of material resources have been reported or discovered. Factories and institutions, in which many DOSAAF units are found, furnish quarters for study groups. 67/ Regular military units give material aid, including the use of military equipment, ranges, and instructors of the regular military establishment. 68/ DOSAAF primary units, with permission from higher headquarters, may operate various sporting activities such as shooting galleries, parachute towers, and driver training courses on a cost accountability basis. 69/ Municipal executive committees have been ordered to furnish DOSAAF with aid and appropriate quarters. 70/

III. Plans and Training.

A. Security.

Civil defense information in the USSR is strictly controlled for security reasons. 71/ Indications of this control are the relatively few published instructions for civil defense outside the popular level, unpublished postwar legislation, and the use of cover words. 72/

B. Personnel.

Personnel appointed to MFVO positions are probably screened for political dependability as well as for technical qualifications.

Personnel for DOSAAF, the largest civil defense training organization, may be less closely controlled. Membership requirements are, however, similar to those for the Komsomol and preclude the admission of anyone not supporting the regime or whose family is suspect. 73/ [redacted] there are no Latvian DOSAAF instructors in Latvia -- only "Soviets." 74/ Presumably other personnel used in the civil defense structure are selected on the basis of loyalty as well as ability and are informed on a "need to know" basis. 75/

50X1

S-E-C-R-E-T

C. Plans.

Civil defense, like other aspects of the Soviet system, is prepared according to plan. Plans are probably prepared in detail at the operating level -- in rayons, cities, and important enterprises. For example, planning missions of the city MPVO staff include the preparation of the action plan, plans for financing, plans for civil defense education, 76/ and probably procurement plans.

World War II instructions required that operational plans for enterprises be drawn up by the MPVO staff in accordance with instructions from the ministry concerned and the Chief of MPVO (then the manager) of the enterprise and in accordance with the city's MPVO requirements. It is probable that over-all civil defense preparation is accomplished on the basis of the five-year and yearly plans. 77/

It was reported in 1950 that the USSR planned to train 5 million citizens a year in civil defense, 78/ and a Soviet publication referring to the 1950 Plan called for enlistment of "tens of thousands" of instructors for the development of air defense study groups. A "special plan" for air-raid shelter construction, probably based on particular legislation, 79/ was mentioned in a Soviet manual of 1952. 80/ Developed plans for specific city, sector, and enterprise civil defense groups (such as for groups for Moscow city or the Tushino area) have not been uncovered, probably because they are classified "Secret" or above. Plans at the time of World War II called for a great deal of initiative at the city level, using local functionaries and organizations to form civil defense services, crews, and the like. Directives included the use of groups such as the police, the fire guard, local medical personnel, local communications personnel, area transport, communal services, and repair crews as the nuclei of civil defense forces. Auxiliaries were provided by OSOAVIAKhIM and by the Red Cross and Red Crescent Societies.* Detailed planning as well as recruitment, training, financing, and supervision was the function of the Chief of MPVO of the city. 81/

D. Training.

It seems probable that the MVD officers of the MPVO receive special training before taking over duties as chiefs of staff in cities, rayons, and important enterprises. Such training might take the form

* See VI, B, 1, a, (3), p. 49, below.

S-E-C-R-E-T

of special courses for already commissioned MVD officers or the officer-candidate type of schooling. MVD schools have been reported in Leningrad, 82/ and MVD officers were detailed from Leningrad to Tallinn in 1952, where they were to supervise civil defense preparations. 83/

According to Soviet publications, the Chief of MPVO of a city is responsible for the training of the command and administrative staff of the MPVO. 84/ To help him in this function, a Chief Supervisor of Education is appointed. Tasks entrusted to the Chief Supervisor are planning and implementing local air defense training, supervising instructors, and reporting on completed drills and instruction with a complete analysis of work, including recommended measures to eliminate shortcomings.

1. Technical Facilities Identified with the MPVO.

The MPVO maintains a Central Scientific Research Laboratory, which conducts research in development and design aimed at improving techniques and materials for civil defense. 85/ A medical experimental plant for MPVO is located at Odessa. 86/ It seems probable that research personnel of GUMFVO have taken part in nuclear tests. It was announced in the fall of 1955 that a Soviet hydrogen bomb test had included "wide-scale research ... on questions of protecting human beings." 87/ A returning German prisoner of war reported that in Sverdlovsk he saw apartment air-raid shelter plans which originated from the "Planning Institute," Leningrad. 88/

2. PVKhO Schools.

PVKhO and atomic defense training has received steadily increasing attention in the DOSAAF program. It has become compulsory for every DOSAAF primary organization to set up study circles for PVKhO. To train instructors, DOSAAF operates a network of schools and training courses. Mention has been made in DOSAAF publications of factories sending workers to the oblast or local PVKhO school for training, and these workers, on their return, are utilized as civil defense instructors. 89/ Graduates of these schools are also utilized to teach leaders of self-defense groups from offices, homes, and schools. These PVKhO schools probably are supervised by the MPVO, because MPVO officials have participated in examinations of graduates. 90/

S-E-C-R-E-T

3. Factory Training.

During the last several years, emphasis has been placed on the formation of DOSAAF primary units in plants, 91/ a practice which is undoubtedly aimed in part at providing civil defense training for the target crews and shop sections as well as for the general body of workers. Major plants probably have the advantage of the presence of a trained Chief of Staff of MPVO. The guard force, firemen, maintenance personnel, and medical personnel of the individual plants are sources of instructors and also form the nuclei for the various civil defense groups. Reports on civil defense drills in ob"yekty are meager. [redacted] practice alerts were held once a month in a confectionery plant in Kiev, 92/ twice a month in a hospital in Baku, 93/ and every 6 months at a scientific research institute near Leningrad. 94/ A prisoner of war reports that smoke camouflage exercises were carried out at a chemical plant about every 2 months. 95/ It is probable that drills are held periodically in most major plants. Training at this level is feasible because DOSAAF organizations are widespread in economic installations 96/ and because the majority of workers in these plants must be presumed to have had basic PVKh0 instruction. It has been noted in a DOSAAF publication that citizens who passed the PVKh0 requirements should be given the course again in 2 years, 97/ indicating that in some areas, at least, the first cycle of training had been largely completed.

50X1

4. Training in Schools and Universities.

As noted above, instructors for PVKh0 in schools have been trained by DOSAAF. DOSAAF units present in higher schools aim at preparing students as potential leaders for civil defense activities by giving them thorough theoretical and practical training in the organization of passive defense for factories and other economic installations. 98/ Children in lower schools also are trained in civil defense in accordance with a special plan. 99/ In the autumn of 1953, for example, it was reported that all Estonian school children were to get 8 hours of training in behavior and in air, fire, and chemical defense. Some gas masks and protective clothing were issued for training. 100/

- 23 -

S-E-C-R-E-T

S-E-C-R-E-T

5. DOSA AF Training Program.

DOSA AF is responsible for civil defense training for the general population. Within each DOSAAF primary unit there must be study groups for PVKhO. 101/ An article in Pravda in 1954 redefined the priority goal of DOSAAF as the giving of "modern" PVKhO training to "all" the population. 102/ It was reported in 1952 that civil defense instruction was to be given in three phases, as follows 103/: (a) to members of the Communist Party and its affiliates, (b) to industrial workers, and (c) to all civilians. The insertion of the word "all" in the Pravda article implied that air defense training had entered the third phase. The training given under the PVKhO program includes instruction on air-raid shelters, construction of trench shelters, first aid, fire fighting and fire-fighting equipment, types of gas and gas detection, and gas defense measures (including gas masks, shelter measures, decontamination, and care of water and food). 104/ Other subjects are the recognition of types of bombs and warning signals and general familiarization with the MPVO system. On completion of the course those who successfully pass a practical examination are awarded the title of "Ready for Air and Chemical Defense" (Gotov k PVKhO). 105/ In view of the past emphasis on introducing DOSAAF and its activities into schools, factories, institutions, state and collective farms, and machine tractor stations, and in view of the call for the training of "all" the population, it is possible that most DOSAAF members and workers and students in the above-listed points have been given basic instruction in civil defense. The next goal then logically would be to reach the remainder of the population. During 1952-53, house managers in the Estonian SSR were put through special MPVO courses by DOSAAF 106/ which would also be timely for the current organization and instruction of the self-defense groups in dwellings.

one aim of the instructional program is to give all civilians a 20-hour course in civil defense instruction. 107/ Instructions published in 1956 disclose that the course now includes antiatomic measures. 108/ Completion of the course is to be entered on DOSAAF membership cards, and citizens who are not members will be issued appropriate certificates if they change residence or place of employment. Trainees who receive unsatisfactory grades must repeat the course. 109/

50X1

S-E-C-R-E-T

6. Drills.

Reports of air-raid drills have been few, but the training carried out in DOSAAF units, institutions, plants, and schools could easily be carried on internally. Blackout driving exercises were reported in Mogilev in 1952. 110/ German prisoners reported periodic sounding of air-raid sirens in Sverdlovsk before they returned to Germany in 1953, 111/ and one stated that the population had to "disappear" from the streets. 112/ From Stalingrad comes the only description of an air-raid drill in a sector of a city. As described by a German prisoner of war, it included a blackout, movement of people to shelters, and a stoppage of traffic. The only vehicles on the street were police jeeps, ambulances, and fire trucks. Auxiliary civilian firemen were noted. All personnel (presumably in the services) wore gas masks, and simulated "hits" and casualties were part of the exercise. 113/ With the current priority for giving civil defense training to the general public, sector and citywide drills will steadily become more feasible and would be a logical development at the present time.

7. Training of MPVO Formations.

A recent civil defense manual stresses the necessity for group training and practical exercises for MPVO personnel. Training in three steps is recommended, as follows: (a) the leader provides a demonstration and explanation, (b) the trainees perform the maneuver under supervision, and (c) the trainees are drilled to acquire skill in performance. 114/ It has been reported that trainees must devote 75 hours initially to such training, that they are to repeat the course every 2 years, and that the individual is trained in a variety of tasks so that personnel may be interchangeable. 115/

The staff and leaders of MPVO are to be trained through a variety of methods including lectures, seminars, independent studies, map and sand table exercises, staff training (similar to command post exercises in the US), demonstrations, and conferences on methods. 116/

- 25 -

S-E-C-R-E-T

S-E-C-R-E-T

E. Behavior Instructions. 117/

1. "Threatening Situation."

Announcement of a "threatening situation" indicating that an air attack is possible is made by radio broadcast (probably over wired speakers only) and by publication of the regulation by the Executive Committee of the local Soviet, presumably in newspapers and on wall posters.

Decrees of the executive committees of the various Soviets (at republic, oblast, and local level) must be obeyed by all, at least in civil defense matters. Local decrees, issued initially, establish leadership duties, state the order in which shelters are to be made ready, and give the behavior rules for the general population. Civil defense chiefs at all levels are responsible for notifying workers and residents of the threatening situation and seeing that behavior instructions are given to everyone. Civil defense organizations are to be assembled and made "combat ready." This includes the establishment of round-the-clock duty posts. Shelters, which have been used for economic purposes (probably for storage, residential, or shop space), are to be cleared immediately and made completely ready. Shelter signs are to be posted -- this apparently explains the absence of shelter signs which has been noted by foreign observers. Simple covers such as dugouts and trenches are prepared wherever air-raid shelters are lacking. Means for individual chemical defense (gas masks) are probably issued and are to be carried at this time. Fire precautions are thoroughly checked, and blackout is instituted by nightfall. Loudspeakers (probably of the wired network) are to be turned on to receive civil defense announcements.

2. Air Alarm.

Announcement of an air attack is made by a 3-minute sounding of whistles, sirens, and the like and by radio announcement. Citizens on the street put gas masks in the "ready" position and take shelter as directed. People in dwellings send children and infirm persons to the shelters, cover food and drinking water, and turn off utilities. If they have no other duties, they then take shelter. Self-defense teams, except those charged with blackout and movement, report to their place of assembly, check or receive equipment, and take shelter. All teams report "ready," if possible, to the house chief. Personnel of other civil defense formations assemble and act as instructed by their commanders.

S-E-C-R-E-T

3. Gas Alarm.

A gas alarm is signaled by striking a metallic object and by radio. All those not in a shelter put on gas masks, and in shelters the gas-filtering mechanism is started. The explosion of an atomic weapon is automatically the signal for a gas alarm.

4. All Clear.

When the "all clear" is announced, personnel may leave shelters and resume their normal routine. However, if a gas alarm has been announced or a nuclear weapon exploded, the population is to remain in shelter until special instructions have been received from civil defense officials.

IV. Air-Raid Shelters.

The use of air-raid shelters is being emphasized in passive air defense preparations in the USSR. Noting World War II experience, the newspaper Krasnaya zvezda has said that troops in town under air attack should make use of cellar shelters. 118/ This presupposes the existence of numbers of such structures, but the failure to mention massive, deep-level shelters may indicate a security restriction rather than a deficiency in this respect.

During World War II the Moscow subway was used as a mass air-raid shelter -- it has been reported that the subway was in part designed as such. 119/ The subway is also reported to have been the location of a key power switchboard and some federal offices. 120/ At the height of the German air raids it was estimated that 750,000 people were sleeping in the subway. 121/ The subway system has been expanded since the war, and plans for further expansion have been announced. 122/ A US correspondent returned from Moscow felt that the expansion of the subway was unwarranted by transportation demands and described it as "the world's largest and safest air-raid shelter," noting its great depth and central location. 123/ DOSAAF exhibits related to air defense have included pictures of a subway station, indicating that the USSR is well aware of the possible use of the subway as a bomb shelter. 124/ An underground railroad is also under construction in Leningrad; one section, 10.8 kilometers long, was opened in late 1955. 125/ It is reported that the tunnels will "lie deeper than in Moscow." 126/ This must present interesting problems of construction in a city built on a swamp. Work on a subway in Kiev

S-E-C-R-E-T

has also been periodically reported; a station under construction was reported by a Western observer in 1954. 127/ Aside from these presumably adaptable subways, massive urban shelters specifically for the civilian population of the USSR have not been reported.

It is, however, becoming apparent that the USSR is spending considerable time, money, and materials on a construction program for other types of shelters. These are the basement-type shelters which reportedly are built into new masonry structures -- public buildings, apartment houses, stores, clubs, and the like. Khrushchev was interested in shelter construction before World War II, when he gave instructions that this type of shelter was to be included in new buildings along the route customarily used by government officials when commuting from the western suburbs of Moscow. 128/ Such shelters, ordered in 1938, were to be gasproof and filter-ventilated and were to have ceilings at least 10 inches thick, made of reinforced concrete. The source of this information stated that Moscow schools built in the late 1930's included similar protective measures and also that government office buildings were modified to include shelter during the same period. 129/ Some reports on the construction of air-raid shelters were received between 1949 and 1953, but they hardly make it possible to form any firm conclusions as to the size of the shelter-building program in progress. In 1951 and 1952 the DOSAAF publishing house in Moscow published manuals giving schematic diagrams of cellar shelters for masonry apartment buildings.* 130/ These manuals, by I.I. Savitskiy and P.M. Kirillov, are basically civil defense training manuals for the general population. In addition to shelters constructed according to a "special plan," Kirillov mentions the conversion of existing cellars, and he states that cellar shelters give protection to the population against shock wave and splinters from demolition bombs alongside the building and also against a cave-in of the upper part of the building. These cellar shelters probably are similar to "Category 2"**- shelters of World War II, which were designed to withstand collapse of the buildings. 131/ In describing a shelter, note was made of smoothly plastered airtight walls to prevent gas leakage, double airtight doors, and a filter ventilating installation which would furnish air directly or through filters. The air was to be drawn in by an electrically

* For sketches of apartment air-raid shelters in the USSR, see Figure 3, following p. 28.

** Air-raid shelters in the USSR are divided into categories according to their strength.

Figure 3

SKETCHES OF APARTMENT AIR-RAID SHELTERS IN THE USSR ¹³²

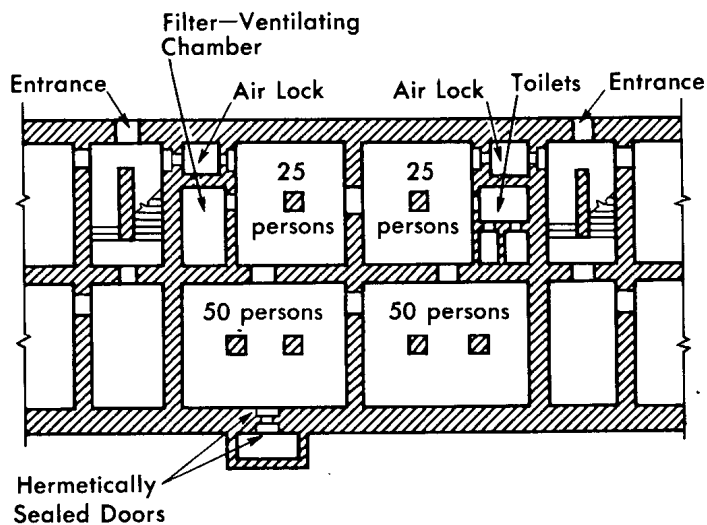

FLOOR PLAN

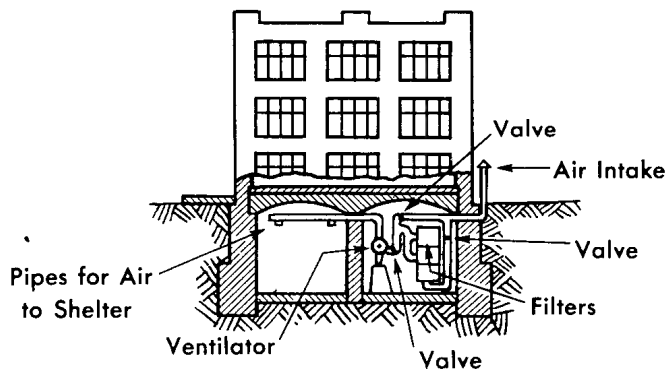

VENTILATING SYSTEM

S-E-C-R-E-T

powered fan which could be manually operated in an emergency. A shelter, according to the manuals, should have water, sewerage, heat, light, and hand tools for emergencies. A manual [redacted] describes similar plans for a civilian-type shelter and also describes in some detail the filtering system. The fan is ideally connected to two intakes on opposite sides of the building, and the filters are in the form of metal canisters, mountable in series to attain the required volume of filtered air.*

50X1
50X1

Many repatriated German prisoners, who were interrogated between 1953 and 1956, had worked on masonry construction in the USSR. They described cellar shelters in masonry apartments at such varying locations as Sverdlovsk, Asbest, Pervoural'sk, and Revda in the Urals; Stalingrad on the Volga; and Kiev, Krasnopol'ye, Kadiyevka, and Stalino in the Ukraine. 134/ [redacted] cellar shelters in Rustavi 135/ and in Khabarovsk in East Siberia. 136/ It thus appears likely that extensive shelter construction has been going forward in implementation of the plan referred to in the manuals of 1951 and 1952.

50X1

The descriptions of apartment shelters given by the returned prisoners of war were remarkably consistent with the plans in the publications mentioned above and with one another.** Among the items mentioned were housing built according to "type" and "series" plans 137/ and "shelters built in accordance with new air-raid precaution legislation." 138/ [redacted]

50X1
50X1

Although these prisoner-of-war reports (numbering around 100) have some variations, a more or less standard pattern is evident. The typical report estimates the cellar depth to be 2 to 2-1/2 meters (m), with walls 40 to 85 centimeters (cm) thick. The estimates of ceiling thickness vary considerably from 15 to 60 cm, including reinforced concrete plates. The difference in thickness may be caused by variations in the span width or by the inclusion of a finished flooring in some estimates. The doors to the shelters -- of steel or metal-clad wood -- are double, hermetically sealed with rubber gaskets, and have a gas lock between them.*** Specified in some descriptions are escape

* For sketches of Soviet gas filters and a schematic diagram of the interior of one filter, see Figure 4, following p. 30.

** For a sketch of an apartment air-raid shelter near Kiev, see Figure 5, following p. 30.

*** For a photograph of a Soviet shelter door, see Figure 6, following p. 30.

S-E-C-R-E-T

passages which are essentially concrete-lined tunnels with covered man-holes at some distance from the dwellings. In apartments where a tunnel is not provided, escape hatches are built into the upper cellar wall. Two toilet rooms are customarily installed, and first-aid stations 140/ and showers have been identified in some shelters.

[redacted] 50X1
[redacted] inspecting officers insisted 50X1
on extremely smooth plaster-coated walls. 142/ These probably are
measures to guard against gas leakage. Other antigas measures
described include the hermetically sealed doors (common to all reports)
and ventilator ducts for the air-purifying unit. [redacted] 50X1

[redacted] 50X1
[redacted] A prisoner of war observed a stainless 50X1
steel gas-detection pipe (three-fourths of an inch in diameter) through
a shelter wall connected to the filter ventilating apparatus, [redacted] 50X1
[redacted] pipelines in cellars were splinter- 50X1
proof. 146/

The walls of the shelters are built of brick, concrete, or stone,
with the floor and ceiling of concrete.* Concrete mixtures used in
air-raid shelters are reported in two instances. [redacted] 50X1
a mixture of 1 part of "500" cement to 5 parts of sand. 147/ (This
does not seem probable, [redacted] 50X1

[redacted] A more plausible mixture 50X1
reported was 1 part of "400" cement, 2 parts of sand, and 2 parts of
gravel. 148/ Cement of good quality ("400" and "500") evidently was
not always available, and the substitution of "250" has been noted.
There is only one description of steel reinforcement in ceilings,
which said that the ceiling contained 12-millimeter (mm) steel wire
mesh and 5 to 6 metric tons of iron per 100 square meters (sq m). 149/
This seems high unless the steel used in structurals was included in
the estimate.

The construction of shelters was inspected by military officers. 150/
In view of the known role of the MPVO in monitoring civil defense con-
struction, it is likely that these were MPVO officers or engineer per-
sonnel loaned to the MPVO for inspection purposes.

* For sketches of apartment air-raid shelters in Stalingrad and
Stalino, see Figure 7, following p. 30.

SKETCHES OF SOVIET GAS FILTERS ¹⁵¹

Figure 4

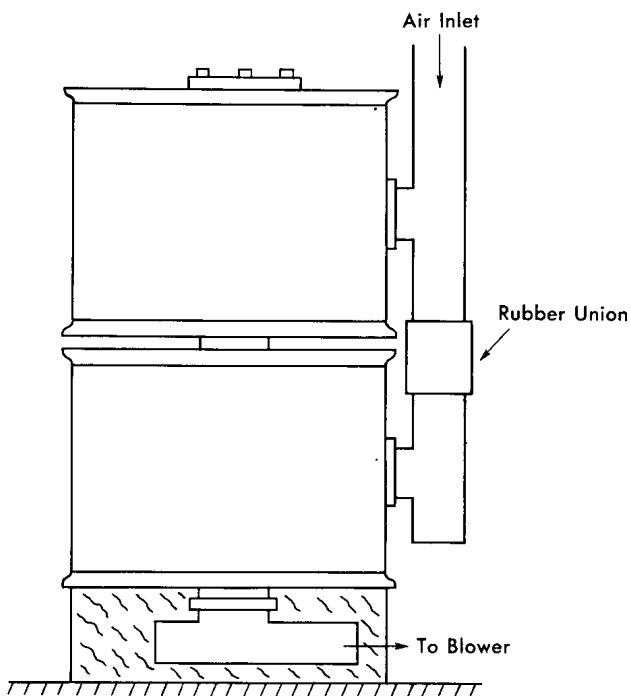

FILTER-SORBENT FPU-100

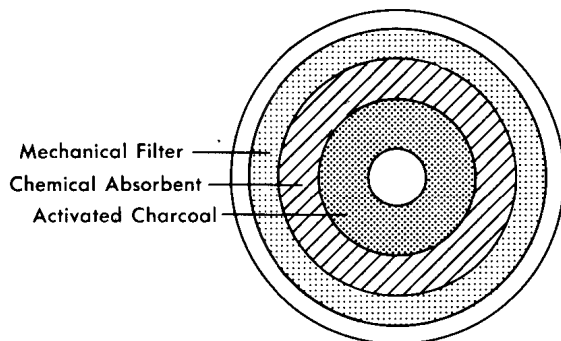
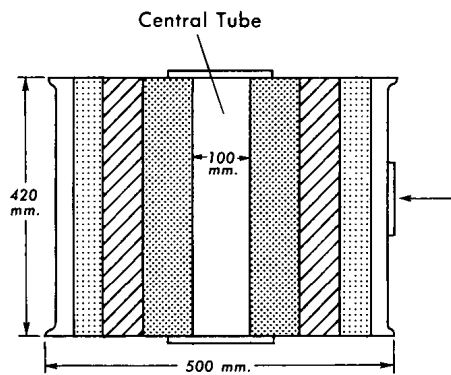

SCHEMATIC CONSTRUCTION OF FPU-350

Figure 5

SKETCH OF AN APARTMENT AIR-RAID SHELTER NEAR KIEV, USSR¹⁵²

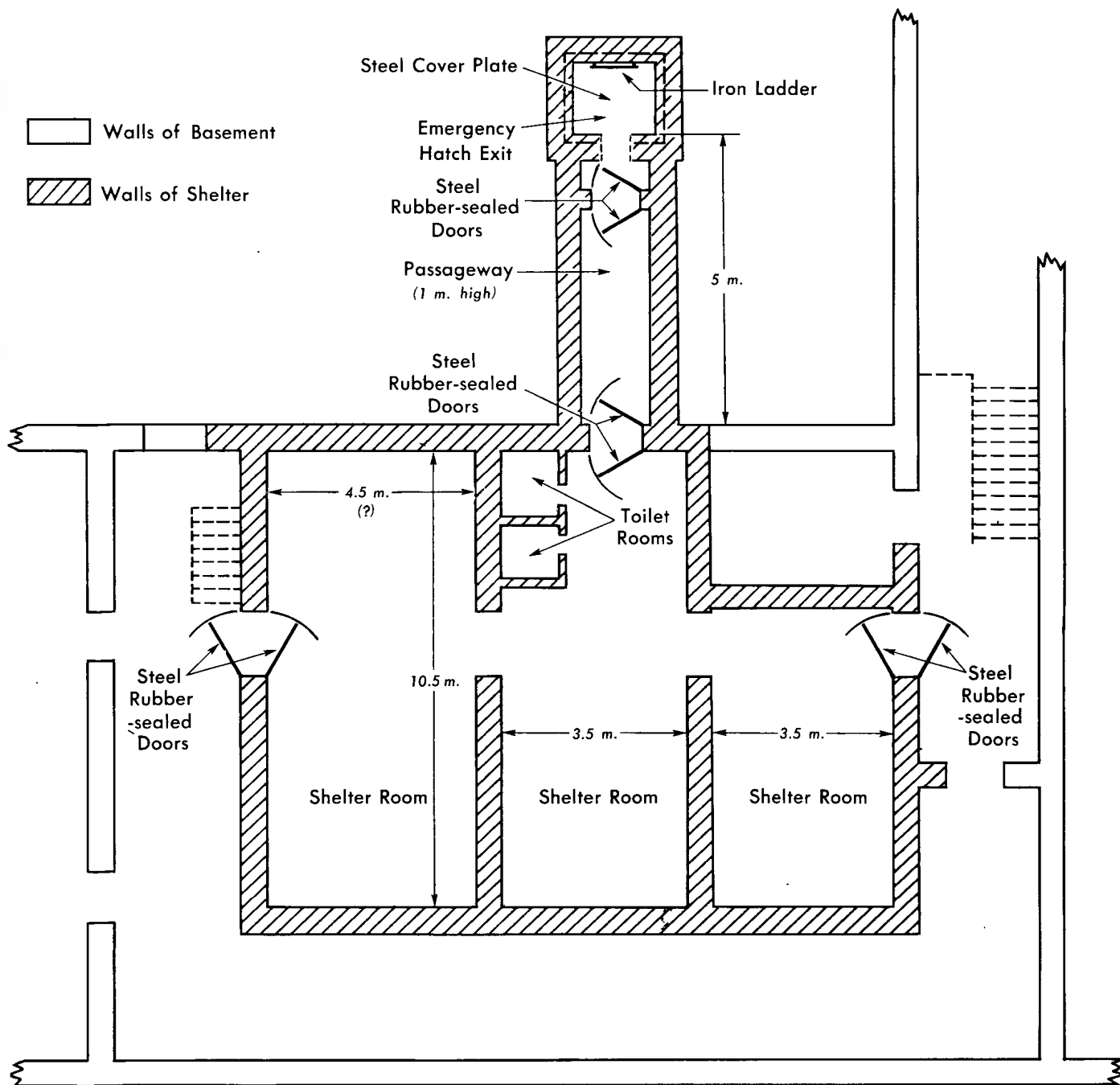

FLOOR PLAN

14749 (First Revision 10-56)

50X1

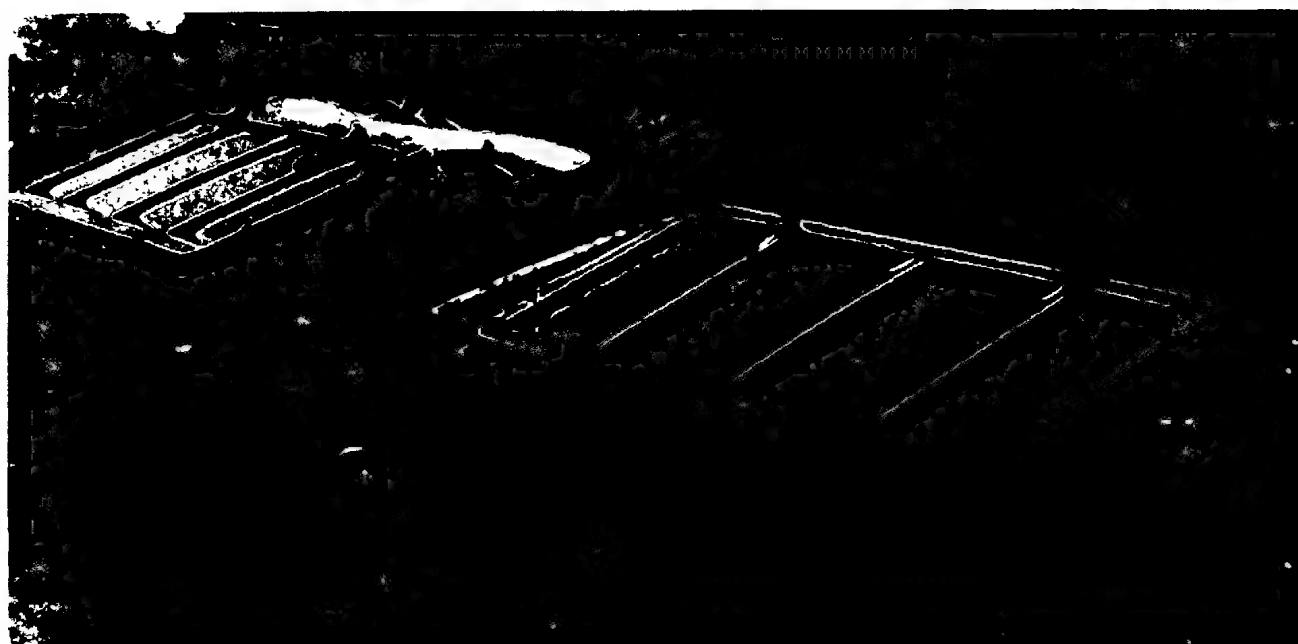

Figure 6
STEEL BULKHEAD DOORS FOR BASEMENT AIR-RAID SHELTERS
Prague, Czechoslovakia

24360a



50X1

SKETCHES OF APARTMENT AIR-RAID SHELTERS¹⁵³ Stalingrad and Stalino, USSR

Figure 7

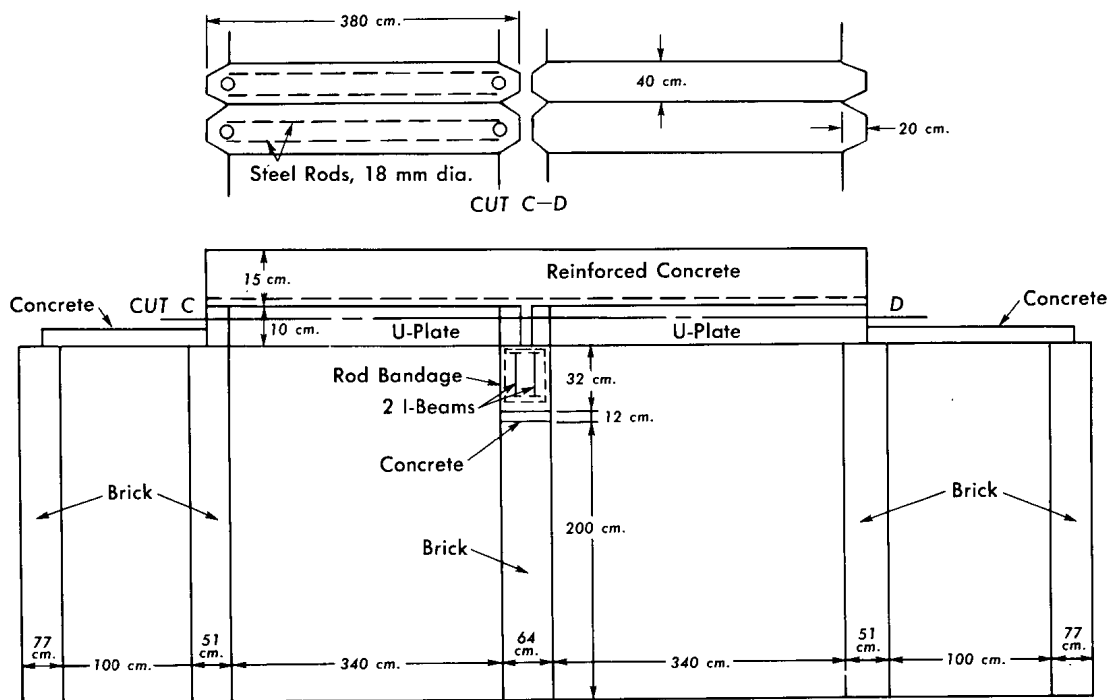

CROSS SECTION OF AN APARTMENT SHELTER
STALINGRAD
MEMORY SKETCH

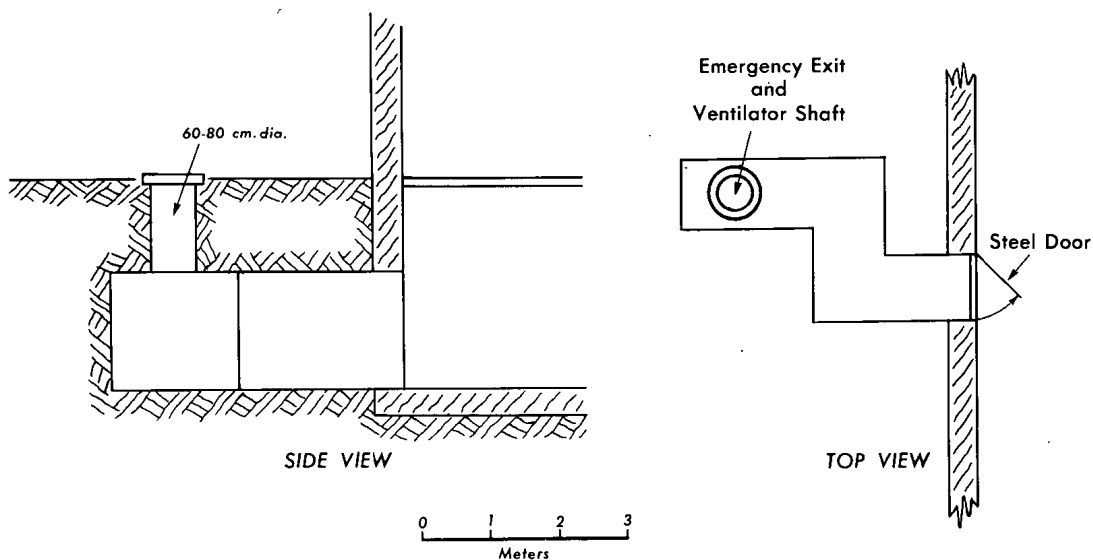

ESCAPE HATCH OF AN APARTMENT SHELTER
STALINO
MEMORY SKETCH

S-E-C-R-E-T

The above descriptions of air-raid shelter construction cover only about a dozen important industrial locations, cities which happen to have been visited by German prisoners of war. There is every reason to assume that similar construction also has been going on in other areas, although fewer reports on them are available.

Air-raid shelter construction dates at least from 1949. Returning prisoners of war are substantially in agreement that all new masonry construction which they saw or heard of in 1952 and 1953 included cellar shelters. [redacted] apartment

50X1
50X1

shelter construction started as early as 1947. 154/ [redacted] shelters were started in 1949, 155/ and that in 1950 shelters were generally included in new apartments in Krasnopol'ye, Sverdlovsk, and Stalingrad. 156/ [redacted] "all [new buildings] since 1951" included cellar shelters in Stalingrad and Stalino. 157/

50X1

[redacted] there are practically no cellar shelters for civilians in the Estonian SSR, but shelters are reported completely ready in buildings used by the armed forces, the militia, and the state security forces. In May 1953, work was in progress to construct air-raid shelters in all government buildings in the Estonian SSR. 158/ Completion of some of these was reported in 1955, and construction was continuing. 159/

50X1

Some priority as to personnel evidently has been used in allocating new apartments and, therefore, air-raid shelters. The earlier construction during 1948-51 probably was largely allocated to Party and government personnel. 160/ Some of the German prisoners of war who worked on apartments in 1953 reported that there was grumbling about the allocation of apartments to these more privileged groups, but several stated that apartments were also occupied by workers in an armaments plant, 161/ employees of a copper combine, 162/ postal telegraph employees, 163/ coal mine laborers, 164/ and others who could be grouped under the heading of workers in essential industry. 165/ The logical system of priorities which seemingly has been followed in the provision of improved housing is as follows: first, government, Party, military, and supervisory personnel; second, workers in essential industry with higher paid technicians having first call; and, third, the general population as housing becomes available. The lack of apartment shelters reported in the Estonian SSR may only reflect limited housing construction in that area.

S-E-C-R-E-T

A quantitative estimate of the number of apartment shelters available in the USSR is difficult. [redacted] prisoners of war did not have too much opportunity to observe outside the areas in which they worked. It is possible to cite some interesting generalities. In Revda, prisoners of war built about 150 apartment houses with cellar shelters 166/ from 1951 to 1953, and they reported that "huge" numbers of apartments were being built concurrently by Soviet labor. One prisoner of war returned from Revda estimated that two-fifths of the population lived in postwar structures in the new residential district. 167/ A returned German doctor, who was released in 1953, reported that in Voroshilovgradskaya Oblast (Ukrainian SSR) "most of the buildings were equipped with air-raid shelters." 168/ Another returned prisoner reported that many of the wooden buildings in Sverdlovsk had been replaced and that 90 percent of the town was composed of brick residences. Heavy construction was going on in all sections of the city from 1950 to 1953. 169/ Although not conclusive, these few statements added to other prisoner-of-war reports on various Soviet cities give the impression that cellar shelters are available to a large segment of the population in important target areas.

50X1
50X1

The shelter program is not limited to the "luxury" apartments. Returning Germans have reported detached shelters, shelters in industrial construction, and shelters in public buildings. Detached shelters were built in Stalino in 1952.* 170/ Although details in the reports vary, such shelters are below ground level and have an earth cover 1 to 2 m thick. Masonry walls and reinforced concrete ceilings about 20 cm thick make them somewhat similar to the apartment shelters. Toilet rooms, first-aid areas, gas-filtering apparatus, and double airtight doors are included in these shelters. [redacted]

50X1
50X1

[redacted] A prisoner of war was informed that a change in plan made in 1953 called for the omission of the customary cellar shelters in one residential area. His fellows had prepared two large excavations in the center of the area, and it was rumored that central shelters were to be constructed. Possibly this method has been found to be more economical or practical in some cases than the inclusion of shelters in each apartment building.

* For a sketch of a Soviet detached air-raid shelter in Stalino, see Figure 8, following p. 32. For a sketch of a detached shelter from a 1956 Soviet manual, see Figure 9, following p. 32.

Figure 8

SKETCH OF A DETACHED AIR-RAID SHELTER¹⁷²

Stalino, USSR

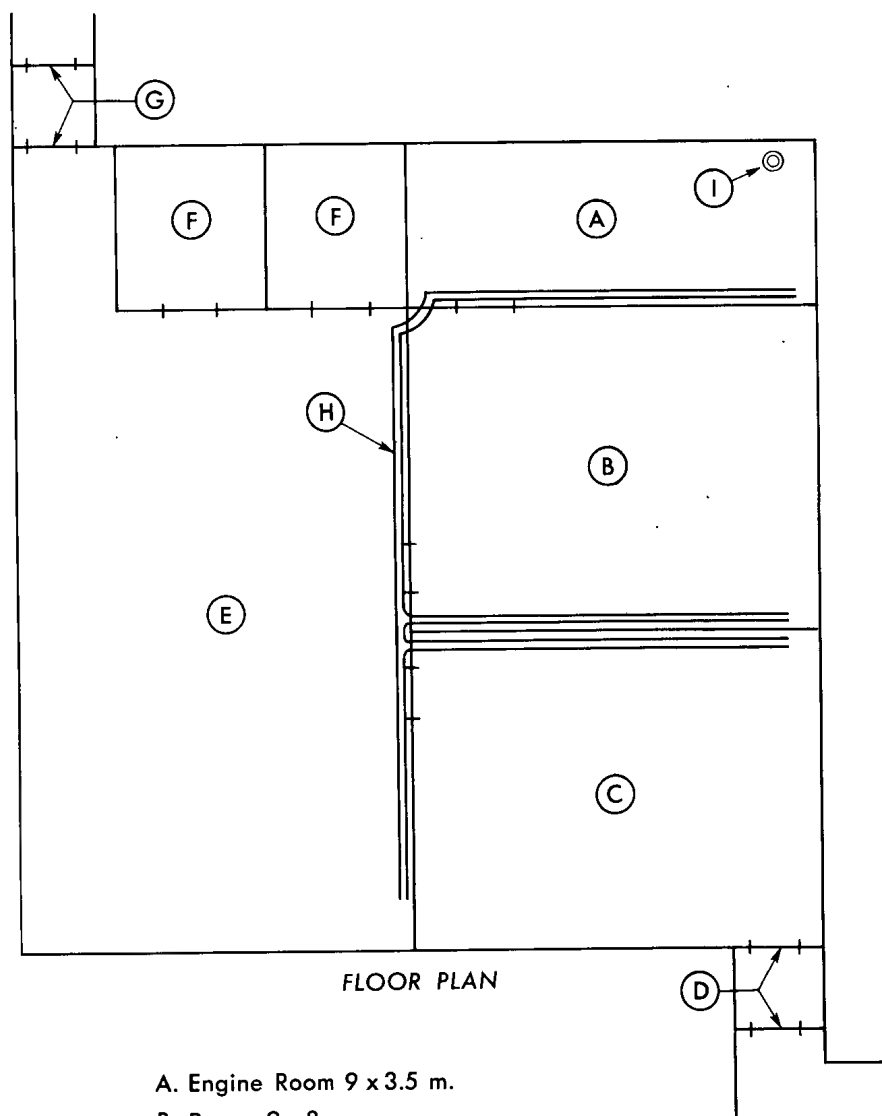

- A. Engine Room 9 x 3.5 m.
- B. Room, 9 x 8 m.
- C. Room, 9 x 8 m.
- D. Gas Trap, Steel Doors
- E. Room, 9 x 16 m.
- F. Toilets
- G. Same as D.
- H. Ventilating System, 150 mm. dia. Sheet Metal Tubes
- I. Ventilating Shaft, 300-400 mm. dia

14751 (First Revision 10-56)

Figure 9

SKETCH OF A SOVIET DETACHED AIR-RAID SHELTER¹⁷³

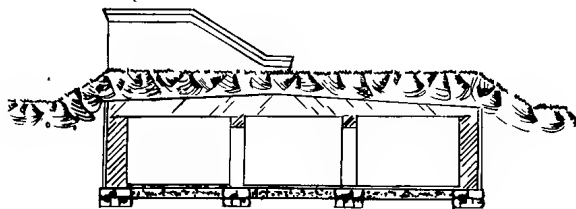
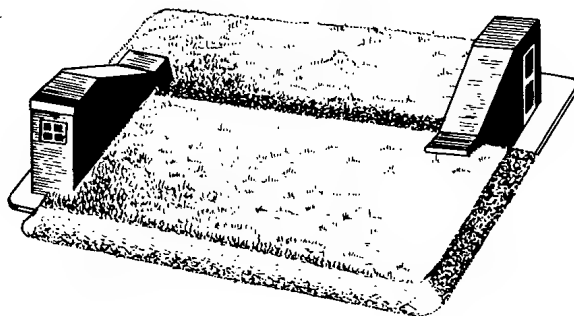

24360 b



50X1

S-E-C-R-E-T

Concurrent with the program for apartment shelters, shelters also have been included in military barracks, government and Party headquarters, clubhouses, 174/ schools, 175/ hospitals, 176/ and department stores. 177/ Some of these were installed as early as 1948, according to reports on the Baku area. In Baku a new Party building with a strong reinforced concrete cellar was completed in 1948. 178/ A building rumored to be the new Government House was reported in 1949 to have reinforced cellar rooms with steel doors. 179/ A military headquarters building in Baku likewise has 6 heavily constructed cellar rooms which are 5 by 6 by 3 m in size, with rubber-lined iron doors. 180/ In the MVD building in Kiev and in the Clubhouse of the Red Army, large air-raid bunkers with gas locks were reported in 1951. 181/ Two other official buildings in Kiev were reported in 1948 to have basements two stories deep. 182/

Plant shelters are also included in new industrial buildings. These have been reported in factories in Sverdlovsk, 183/ Kramatorsk, 184/ Moscow, 185/ Khabarovsk, 186/ Stalingrad, 187/ and Odessa. 188/ There is no reason to believe that these are isolated occurrences. Considering the Soviet concern for developing and protecting an industrial economy, it cannot be supposed that bomb shelters are not being included in new factory installations. The construction of enterprise shelters has been ordered in several Satellites -- in at least one by 1952. 189/ It seems probable that such measures would not be taken in subject states until Soviet industry was well protected.

In areas where formal shelter is not available, the populace is advised to dig dugouts or slit trenches. 190/ The areas for these are preselected by order of MPVO officials, but construction is not started until express orders are received. These covers as designed are wood-lined and may be progressively improved by various measures such as the addition of doors, gasproofing, heat, and light.

Speculation on the number of air-raid shelters possibly available can be based on the number of housing units in masonry apartment buildings. An article in the Soviet Weekly, published in London, gives statistics which differentiate between "flats" and individual houses and countryside dwellings. 191/ Flats, as implied by several pictures in the article, are located in masonry apartment dwellings. Construction figures for flats in the USSR are given as follows: 1951-53, 2,050,000 units; 1954, 600,000.

S-E-C-R-E-T

The 1955 rate of flat construction is given in the same article as 600,000 flats per year. Figures for 1951 through 1955 total 3,250,000 units. Inasmuch as reports indicate that shelters have generally been included since about 1951, only the figures after this date are considered.

If air-raid shelters have been provided during the course of new construction, the number of Soviet citizens having apartment shelters or adaptable basements available may possibly be 16,250,000, a sizable proportion of the 80 million people living in urban areas. Apartment construction is planned to provide housing for 25 million persons 192/ during the current Five Year Plan. Thus the total shelter capacity in apartment dwellings may be adequate to accommodate 41,250,000 people by the end of 1960. This theoretical figure would by no means indicate the total shelter available, because it would be supplemented by bomb shelters in official buildings, industrial installations, stores, schools, Party and club buildings, hospitals, and subways and probably by separate mass shelters. No quantitative figure is available for these, but the number must be substantial, particularly in essential industry and important target areas.

A 1956 Soviet civil defense manual supports the impression that heavier shelters have been or are being prepared in the USSR. Although emphasizing the alleged value of basement shelters, the manual briefly mentions and diagrams bunker and heavy underground shelter construction.* It also indicates a modification in the filter ventilating systems** of shelters to include an antiblast device and an oil-screen, antidust filter. 193/ Both of these devices are probably designed to counter blast and "fallout" effects of nuclear attack. Air-raid shelter construction was not concealed from competent Western observers in 1956, and pictures of apartment shelters under construction in the USSR were obtained.***

* For sketches of Soviet heavy air-raid shelters, see Figure 10, following p. 34.

** For a sketch of a filter ventilating system for a Soviet air-raid shelter, see Figure 11, following p. 34.

*** For a photograph of a compartmentized basement air-raid shelter in Kiev, see Figure 12, following p. 34.

Figure 10

SKETCHES OF SOVIET HEAVY AIR-RAID SHELTERS¹⁹⁴

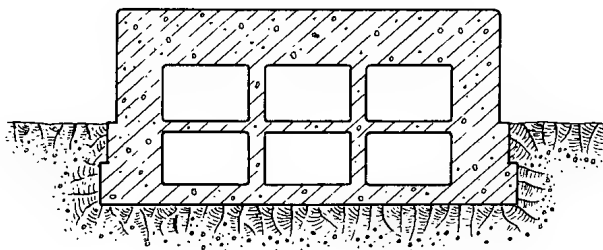

Solid-type Shelter

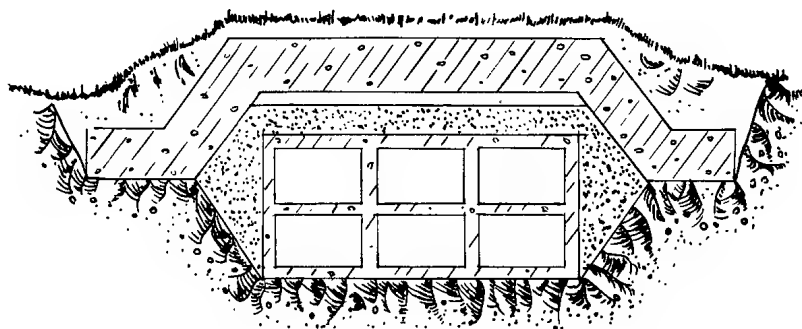

Layer-type Shelter

24360 c



50X1

Figure 11

SKETCH OF A FILTER VENTILATING SYSTEM FOR A SOVIET AIR-RAID SHELTER ¹⁹⁵

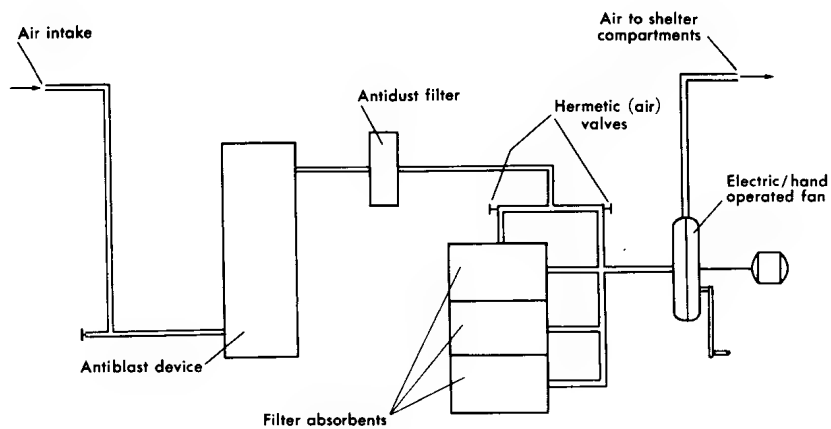

24360 d



50X1



Figure 12
COMPARTMENTIZED BASEMENT AIR-RAID SHELTER
Kiev, USSR

S-E-C-R-E-T

V. Other Related Activities.

A. Police.

Control functions for civil defense will in most cases be the responsibility of the head of the police in a city or rayon. The reinforcement of the militia by auxiliaries has been linked specifically to civil defense in a 1956 Soviet manual. 196/ [redacted] police auxiliaries have been recruited, [redacted] as members of the Communist Party, the Komsomol, and trade unions. 197/ The laxity of militia auxiliary brigades was the subject of criticism in Leningrad in June 1954 -- criticism which probably indicated increasing interest. 198/ Broadcasts of 1956 indicate that Komsomol members particularly are recruited for auxiliary militia. 199/ The regular militia and its auxiliaries undoubtedly form the nuclei of order and security services and crews in the city and sectors. The subordination of the MPVO, police, and fire-fighting bodies to the MVD facilitates their integration into the civil defense system and insures strong legal authority as well as a high degree of control.

50X1
50X1
50X1

B. Fire Defense.

Experience during World War II showed that one of the more dangerous effects of air attack is the igniting of large fires which may unite into conflagrations or develop into fire-storms. 200/ It is therefore important for civil defense purposes to prepare carefully for the possibility of fire through the development of both fire-fighting and fire-prevention measures.

1. Organization.

The fire defense forces of the USSR are under the MVD. The Chief Directorate of the Fire Guard (Glavnoye Upravleniye Pozharnoy Okhrany -- GUPO) in Moscow is the controlling body. At intermediate levels are found Directorates of the Fire Guard (Upravleniye Pozharnoy Okhrany -- UPO). City fire departments form the lowest echelon in the formal fire-fighting structure.

The MVD operates the Leningrad Fire-Fighting Technical School, which conducts a 3-year course for officer candidates between 18 and 23 years of age. Students are maintained at government expense and receive officer rank when graduated. 201/ Instruction for lower ranks probably is given in regional or city fire-fighting schools. 202/

- 35 -

S-E-C-R-E-T

S-E-C-R-E-T

The efficiency of the fire guard probably is good. The Soviet Weekly in an article on Moscow lauds the new fire department for its streamlined fire engines, radio communications, mobile power stations with searchlights, electric saws, and huge emergency water tankers. 203/ It is stated that 48 seconds after an alarm the unit goes through the station gates with personnel in fire-proof suits and steel helmets. Prisoners of war from Stalingrad and Sverdlovsk describe fire forces there as quickly available and efficient 204/ and state that personnel were equipped with asbestos overalls and helmets. 205/ The fire defense forces seem to be adequate for peacetime purposes because no reports are known of excessive incidence of fire in the USSR.

2. Civil Defense and Fire Fighting.

Most large factories in the USSR are reported to have their own fire departments, including trucks and uniformed personnel. 206/ Volunteer fire departments exist in some areas. 207/ The civil defense training program includes fire-fighting training in DOSAAF units, in self-defense groups of dwellings, and in target crews and shop sections of industrial installations.

Under combat conditions it is necessary to have additional fire-fighting forces to send to the aid of stricken areas. These can be provided by an interchange system between areas or by the formation of additional mobile fire-fighting units. No reports have been received of Soviet drills involving the interchange of fire-fighting forces, but this does not indicate that plans for such action are nonexistent.

A recently published Soviet newspaper article on atomic defense states that fire-fighting crews of civil defense forces will be removed to the outskirts of populated areas and located on main highways, where crews and equipment will be placed in shelter. 208/ A 1956 Soviet civil defense manual indicates that it is preferable to disperse the emergency engineering services as well as the fire-fighting forces of civil defense. 209/

New items of equipment for fire-fighting as well as modified tactics have been publicized. One of these is a new fire truck which is said to be used for combating fires in large "industrial centers" and also for civil defense organizations. This truck is probably mounted on a 6-wheel chassis with a 4-wheel drive, which

S-E-C-R-E-T

should result in a moderate capability for off-road operation. It has an announced pumping capacity of 6,000 liters (1,582 gallons) per minute. 210/ A new hand-carried fire pump* has been designed. It has a capacity of 600 liters (158.5 gallons) per minute and weighs about 176 pounds. 211/ The need for light and portable fire equipment was demonstrated by Japanese and Western experience in World War II, when large vehicles were frequently immobilized by damaged and rubble-strewn streets.

3. Auxiliary Water Supplies.

The problem of nearly simultaneous heat and blast is acute in fire defense -- the shock that ruptures water mains, reducing or cutting off the normal supply, is accompanied by large water requirements for fire defense. 212/ Supplementary water supplies may be obtained from natural water bodies and from wells or storage tanks. It is axiomatic that provision of auxiliary water supplies must be accomplished before attack.

Auxiliary water sources -- cisterns and the like -- have been reported in Soviet industrial enterprises. 213/ [redacted]

[redacted] They are described as 9 m in diameter and 5 m deep with the upper edge flush with the ground level. 214/ The preparation of static water supplies is probably quite widespread; certainly some of the European Satellites have been actively making such preparations for the last 3 or 4 years.

Tank trucks have been mentioned as normal equipment for fire-fighting forces in Moscow and probably are also used to augment water supplies by hauling water from natural 215/ or artificial water sources to the scene of a fire where a water shortage has occurred.

The USSR is well aware of the danger of disrupted water systems, and an article published in 1948 described methods of controlling breaks in water mains by emergency repair crews of the MPVO. The means discussed are regional shutdowns and repair by the use of temporary pipe laid on the surface and by fire hoses connected to

* For a sketch of a Soviet portable fire pump, see Figure 13, following p. 38.

S-E-C-R-E-T



50X1
50X1
50X1

S-E-C-R-E-T

hydrants across the break. 216/ These instructions presuppose or specify provision for extra pipe and hose to be used in an emergency.

Tower observation posts are used in Soviet cities for fire-watching posts. 217/ According to a police official who served during most of World War II in the German Air-Raid Protection Police, tower observation posts are valuable for civil defense, not only for the detection and description of enemy plane activity but also for the location and assessment of damage, particularly that resulting from fire. Frequent reports from a network of capable tower observers can keep defense command posts informed of the fire and damage situation and can facilitate the direction of movement of fire-fighting, repair, and medical forces.

4. Fire Prevention.

 Soviet fire-prevention measures before World War II included rigid building code requirements for wiring, fire escapes, fireproofing, and roof construction. 218/ Fire-prevention measures observed by German prisoners of war who worked on apartment construction in 1953 included asbestos-cement ("Eternité" 219/) roofing slabs, attic rafters painted with fire-proof paint, 220/ 

50X1

50X1
50X1

 50X1

Precautionary fire regulations are strict. 223/ This is indicated in open publications by advertisements originated by the fire guard. Prison terms have been imposed on persons charged with permitting fires to develop through neglect of the proper precautions. 224/ Publicity is also given to fire-prevention measures through the use of posters 225/ and newspaper notices.

- 38 -

S-E-C-R-E-T

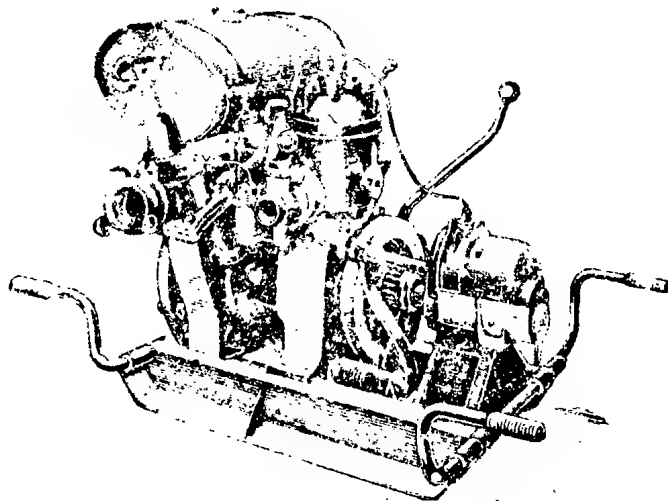

Figure 13
SKETCH OF A SOVIET PORTABLE M-600 FIRE PUMP²²⁶

24360 f



50X1

S-E-C-R-E-T

5. Development of Reinforced Concrete Construction.

The construction of masonry buildings with a high degree of fire resistance within city limits has recently been emphasized in the USSR -- a campaign for the use of precast reinforced concrete (ferroconcrete) in building is under way with much publicity and with the endorsement of top-level officials. Announced aims of the campaign include the growth of socialist production, the conservation of steel and manpower, and the increased comfort of the population. 227/ Although these may be the primary purposes of the new ferroconcrete construction program, it is nevertheless true that the program will reduce fire incidence and reduce the problems of the Soviet civil defense system. The leaders of the USSR probably are well aware of these advantages, and at least one newspaper article refers to the increased fire resistance of ferroconcrete construction. 228/ To make sure that ferroconcrete construction will replace other types of construction, the Central Committee of the Communist Party and the Council of Ministers issued a joint decree in August 1954 229/ which prohibits the drawing up of plans including wooden floors in dwellings of six stories or more, beginning in 1955. The number of stories was to be reduced to four in 1957. Floor limits for cultural and public buildings were even lower.

C. Supplies.

[redacted]
[redacted] it is impossible to make any estimate of the kind and amount of material held by the participating organizations or held in storage. [redacted]

50X1
50X1

[redacted] certain types of supplies applicable to civil defense are stored or stockpiled in various installations.

50X1
50X1

1. In Ob"yekty and Institutions.

A World War II manual referred to MPVO supplies kept in "N2" storage in ob"yekty and institutions which were to be issued on notification of a "threatening situation." 230/ Postwar reports of civil defense equipment in plants enumerate gas masks, gas-protective clothing, coverlets, stretchers, 231/ drugs, 232/ and decontamination materials. Important factories in Riga were reported to have received gas-protective clothing and boots in 1951. At the same time, the installation of sirens and loudspeaker systems was announced. 233/

- 39 -

S-E-C-R-E-T

S-E-C-R-E-T

2. MFVO and MVD.

A variety of supplies probably is stored in MFVO and MVD warehouses. [redacted] an annex to an MVD depot at Vil'nyus contained gas defense materials, including gas masks, curtains, clothing, and chemicals. 234/ [redacted] individual antichemical packets are stored in MFVO warehouses in the Estonian SSR. 235/ An MVD depot at Kiev reportedly stores food, clothing, and boots 236/ in nine concrete buildings. Although this storage may not be intended for civil defense purposes, it would no doubt be made available in case of emergency. [redacted] storage of unidentified radio or electrical equipment in an MVD basement. 237/

50X1

50X1
50X1

50X1
50X1

Reserves of fire-fighting equipment are probably being prepared. These have been reported from the European Satellites, 238/ and again, it seems probable that the USSR would not permit itself to be outdistanced in civil defense preparatory measures. [redacted] an unusual number of fire-fighting vehicles at the principal Moscow fire station. Part of these, [redacted] might represent an emergency reserve. 239/

50X1
50X1
50X1
50X1

3. DOSA AF.

In 1940, OSOAVIAKhIM, the predecessor of DOSAAF, was charged with the issuance and repair of gas-protection devices for the population through a chain of depots and shops. 240/ It seems possible that this arrangement is still substantially the same, because the new civilian GP-4 gas mask was offered for sale through DOSAAF stores. 241/ [redacted] in DOSAAF's storage room in a Kiev plant there were stored gas masks and decontamination materials in amounts sufficient for one shift. 242/

50X1

4. In Apartment Dwellings.

Instructions of 1952 stated that civil defense supplies in apartment dwelling units would be furnished by the executive committee of the city Soviet. 243/ Shelter items include crowbars, spades, axes, and saws. No specific reports as to the equipping of shelters have been received, but the World War II list of equipment included the same types of tool plus specialized (such as first-aid, fire-fighting, and decontamination) equipment for the self-defense teams.

S-E-C-R-E-T

5. Stockpiling.

Although no stockpiles in the USSR have been connected directly with the civil defense program, many items are stored which could be used for civil defense purposes. These items include fuel, food, clothing, automotive equipment, and engineering and medical supplies. 244/

D. Communications.

Instructions indicate that civil defense alarms are to be given by word of mouth, by radio, and by sirens or whistles. In case of a localized gas attack, the alarm is to be given by striking a metal surface. 245/ In some localities, sirens and loudspeakers have been installed or restored since 1950, and sirens have been periodically tested in Sverdlovsk. 246/ In 1955, objects believed to be air-raid sirens were sighted on the roofs of high buildings in Moscow.* Some appeared to have been there for years; others had been freshly painted. They are apparently remotely controlled and spaced one per square kilometer. In some cases, however, they are only a few hundred meters apart. 247/

In operations during World War II the MPVO made use of radio, telephone, and messenger service. The continued use of parallel communications, stressing the use of telephones, has been recommended. A telephone setup prescribed in 1945 links the command post of a city to the air warning service, observation posts, city services of the MPVO, MPVO sectors, and important industrial targets. Through the sector command posts, communications are linked to the sector crews, observation posts, and targets and organizations within the sector. Telephone wires for the MPVO probably would be underground. Duplicate channels are recommended for radio, which would also be linked to mobile units of the MPVO, 248/ but there is no firm indication of how well developed this projected scheme is. Fire and police radio also probably would be used for civil defense purposes.

Operators and technicians for MPVO communications could be furnished or augmented by DOSAAF personnel. DOSAAF club activity includes radio study groups which, according to Soviet publications,

* For a sketch of a supposed air-raid siren in Moscow, see Figure 14, following p. 42.

S-E-C-R-E-T

are quite active. Several instances were noted of the stress laid on radio activity in DOSAAF during 1953 and 1954, 249/ one stating that it was particularly important "at the present time." 250/

Instructions of 1952 to disseminate air defense information by radio were anticipated by a 1949 government decision to complete the "basic radiofication" of the country by 1955. 251/ This radiofication effort was carried through with the cooperation of DOSAAF amateurs.

At present there are more than 19.4 million wired speakers and 6.15 million radio broadcast receivers in the USSR. 252/ It is believed that wired speakers would be the preferred medium for the broadcast of civil defense instructions in case of war and possible air attack.

E. Motor Transport.

Motor transport has many potential uses in civil defense. Vehicles are needed for city services and relief columns and for the use of motor messengers, guides, and motorized reconnaissance groups.

The use of motor messengers, particularly motorcycles, was common in German air defense practice during World War II. They were used both as messengers when communications failed and for the guidance of disaster columns (fire, medical, and the like) arriving from distant localities. Guides were familiar with orders for deployment and the currently passable routes into the disaster areas. 253/

Civil defense training for bus and truck drivers was reported to have taken place in two Belorussian towns in 1952. It included training in general air defense and in blackout driving. 254/ all trucks of "auto bases" in the Estonian SSR must have sets of wooden benches and mounting ladders stored for each truck. 255/ Although these trucks are nominally for the military forces, their potential civil defense uses include evacuation or the transportation of disaster crews.

50X1
50X1

F. Chemical Defense.

The Soviet civil defense program stresses chemical defense. The common instructions for civil defense include identification of gases, care and wearing of gas masks and protective clothing,

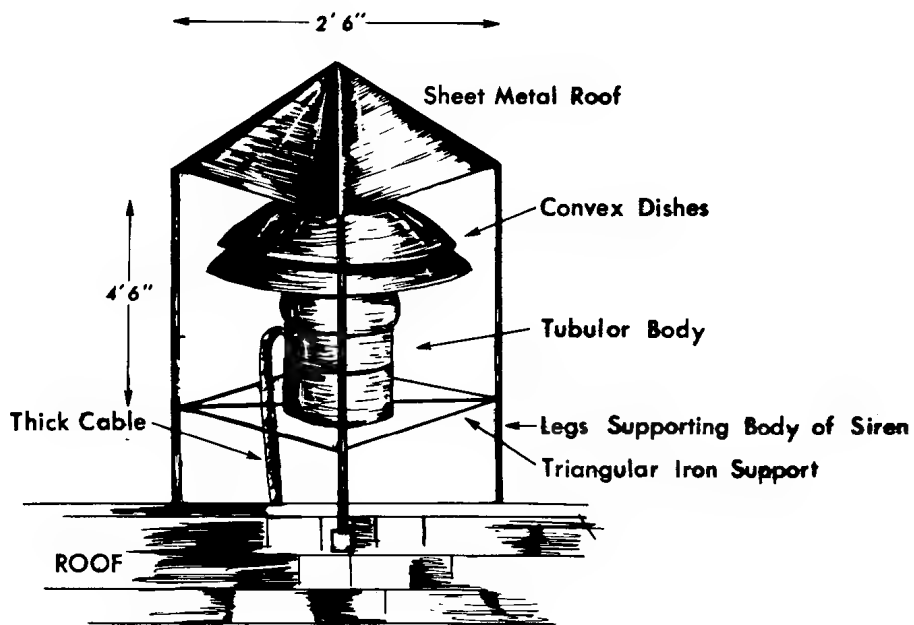

Figure 14
SKETCH OF A SUPPOSED AIR-RAID SIREN,²⁵⁶
Moscow, USSR

24360 g

S-E-C-R-E-T

decontamination procedures, and care of food and water. 257/ [redacted]
[redacted] in schools, factories, and other localities,
observers stress the chemical defense activities noted. 258/

50X1

50X1

Gas masks of high quality (GP-4) were made available to the public through DOSAAF stores in 1953. The price of GP-4 gas masks in the DOSAAF stores is relatively high, however, for the average Soviet citizen, and sales of the mask are therefore believed to be small. The design of the GP-4 mask suggests that it was intended for protection against bacteriological as well as chemical agents, 259/ and a Soviet publication recently stated that it serves to decontaminate the air from toxic and radioactive substances and from microbes and toxins employed in aerosols. 260/

Gas masks and decontamination supplies have been reported to be stored in factories, DOSAAF units, and MPVO warehouses. The amount of such material available is not known, but the present level of training and statements in DOSAAF manuals suggest that key personnel, workers in essential industry, and those expected to perform MPVO duties do have gas masks and protective clothing where required. [redacted]

50X1

50X1

[redacted]
but it is made doubtful by a DOSAAF publication in 1951 which listed one of the duties of the MPVO chief of a dwelling as checking occupants for gas mask needs. 262/

Soviet civil defense manuals give extensive instructions for the decontamination of gassed areas. Such areas are reconnoitered and marked with flags or tapes by antichemical crews or teams. Decontamination of areas and buildings is to be carried out after attack by using various neutralizing agents, the principal ones being slaked lime and quicklime. Several types of equipment are used in decontamination,* but the wide availability of such items has not been reported. It is presumed, however, that these are at least available for training purposes.

Reports of air-raid shelters frequently state that they are equipped with filter ventilating mechanisms or are designed for their installation. As more shelters with such filter mechanisms become available, the vulnerability of the USSR to chemical warfare will decline.

* For sketches of Soviet decontamination equipment, see Figure 15, following p. 44.

S-E-C-R-E-T

S-E-C-R-E-T

[redacted] the effects of chemical attack on an unprepared population could be disastrous from the point of view of morale as well as numbers of casualties. 263/ If this is true, the increasing number of gasproof shelters, the availability of high-quality gas masks, and widespread chemical defense training should be a psychological advantage in the civil defense of the USSR.

50X1

G. Blackout.

Instructions for blackout, published in 1956, are substantially normal. However, it is noteworthy that blackout materials are prescribed to cover windows and other openings which are not only light-proof but which should be impermeable to infra-red rays. 264/ The same instructions describe flame and spark arresters for industrial furnaces.* 265/

VI. Medical Aspects of Civil Defense.

A. Resources.

The centrally controlled, uniform pattern of the medical system 266/ of the USSR is well suited to and already integrated with the civil defense program. 267/ Various opportune arrangements will help the USSR to mobilize medical resources and manpower during and after air attack, such as the stress on preventive medicine, 268/ the plans for emergency conversion of schools into hospitals, the well-developed plan for first-aid posts and personnel, the high-priority requisitioning powers of medical authorities in a stricken area, the allocation of convertible resources in target and target border areas, 269/ the rigid system of personal identification, and the presence of numerous medical facilities in newer key cities in addition to older cities. 270/ Under the added strain of wartime conditions, however, the Soviet dependence upon inadequate facilities and many poorly trained personnel probably will limit their ability to cope with simultaneous and numerous emergency situations.

The Soviet government appears to be taking measures to strengthen the psychological preparation of the population. A propaganda campaign against postwar indifference to civil defense

* For a sketch of a Soviet chamber flame and spark arrester, see Figure 16, following p. 44.

- 44 -

S-E-C-R-E-T

SKETCHES OF SOVIET DECONTAMINATION EQUIPMENT 271

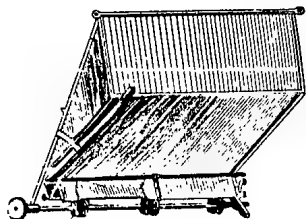

Suspended Decontamination Apparatus

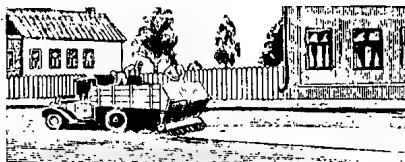

The Suspended Decontamination Apparatus Installed on a Truck.

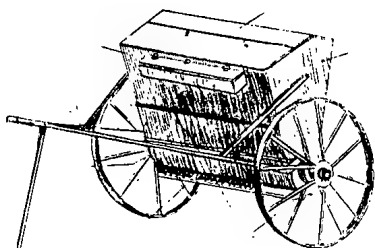

Portable Decontamination Apparatus (VDP)

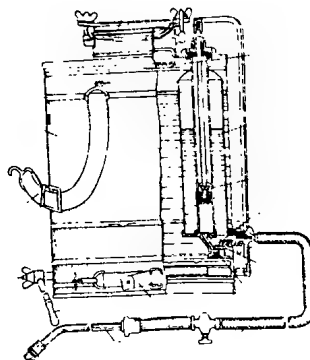

Knapsack Decontamination Apparatus (RDP)



The Handbarrow Sieve in Operation.



Decontamination of Walls with the Calcium Chloride Paste.



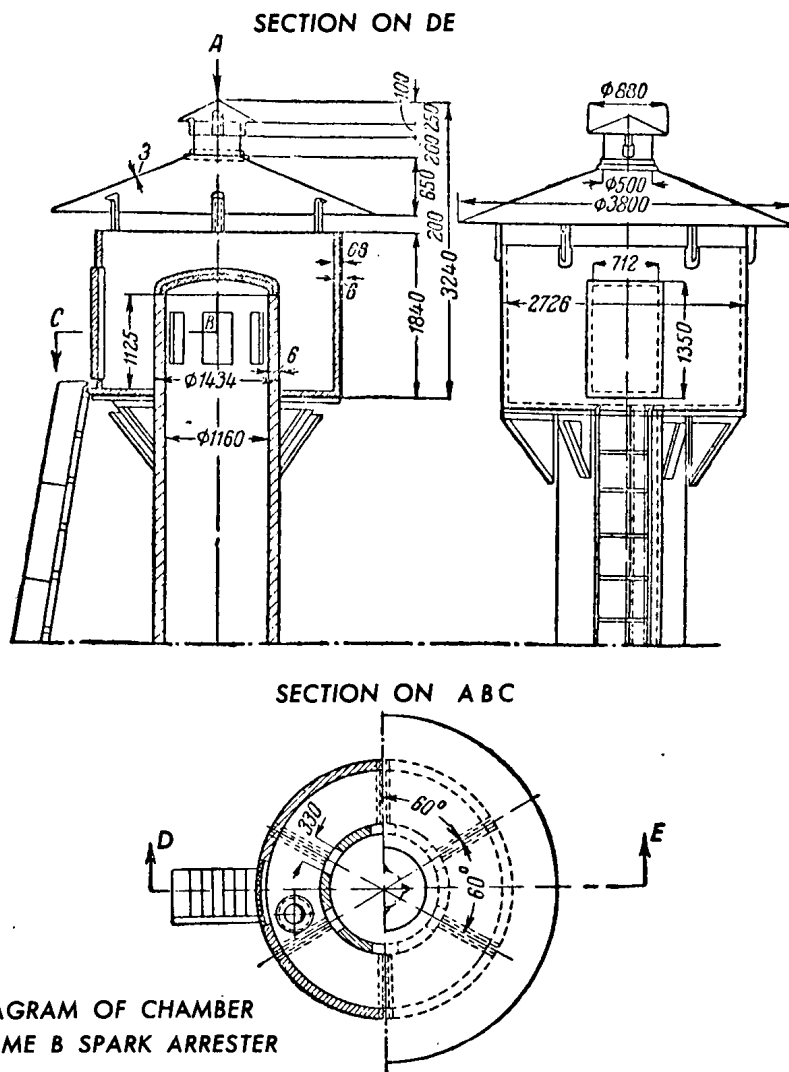

Figure 16
SKETCH OF A SOVIET CHAMBER FLAME AND
SPARK ARRESTER²⁷²

24360 i

50X1

S-E-C-R-E-T

activities is under way, and the masses are apparently becoming more aware of the need for preparation against air attack by conventional and special weapons.

B. Organization and Functions of MPVO Medical and Veterinary Services.

1. Medical Service.

The Medico-Sanitation Service of the MPVO (Mediko-Sanitarnaya Sluzhba, MPVO -- MSS MPVO) is superimposed on the normal Soviet public health system.* It utilizes the existing network of therapeutic and sanitary establishments of local health departments and auxiliary medical services as a basis for emergency medical operations under air-raid conditions. As an integral part of the nationwide MPVO system, it cooperates with PVO Strany** and is subordinate to it in time of war. The vertical organization within the Ministry of Health includes a top-level MPVO section at the ministry level, which channels down by way of the existing internal echelons. Horizontal organization is achieved by working agreements and coordinated activity of the various Ministry of Health echelons with the other interested government agencies, public organizations (particularly the Red Cross and Red Crescent Societies), and a number of lay participating elements.

The most important medical defense organizational unit is at the target level. 273/ The heads of city or rayon health departments also serve as chiefs of the corresponding MSS MPVO units. These executive medical officers supervise the pertinent medical civil defense training and in time of war are charged with reducing the medical effects of air raids to a minimum. Specialized problems related to epidemic control or chemical, biological, and radiological decontamination under air-raid conditions are the responsibility of the State Sanitary Inspector (Gosinspektor). Because of his position as a deputy director of a city or rayon health department, he is also the assistant chief of that city or rayon emergency medical service.

* For the organization of medical civil defense in the USSR, see Figure 17, following p. 46.

** See p. 5, above.

S-E-C-R-E-T

The city organization coordinates all activities performed by all departments which are operating within city limits, including services such as those of the Ministry of Communications, water transport, and military garrisons, taking into consideration the possibility that single establishments and, in most cases, departmental medical institutions may be knocked out of operation, resulting in a shortage of departmental resources. Representatives of the medical services coordinate their plans with the head of the MSS MPVO of the city and report as to civil defense needs such as extra personnel, critical materials, and hospital beds. Physicians of the local military garrisons coordinate their plans with the MSS MPVO of the city in effecting evacuation of medical personnel. If needed, a garrison physician is empowered to support the MSS MPVO of the city, subject to the permission of the garrison commander. 274/ MSS MPVO units are similarly organized in rayons of cities which are divided into rayons; at the head of the MSS MPVO in the rayon is the person who holds the position of chief of the rayon health department. The head of the MSS MPVO of a rayon directs operations through the heads of the MSS in MPVO districts and has at his disposal (a) rayon hospitals which render professional medical aid and treatment to the air-raid victims and (b) reserves for giving assistance to districts. If a city is simply divided into medical districts, an MSS MPVO system is organized in each of these districts. 275/

In rural areas, in large industrial establishments, and in railroad and marine transport the medical civil defense organization takes the same basic organizational form. The senior rural district medical officer is the chief of its MSS MPVO system. A medical civil defense unit is also organized in large industrial enterprises, which have special out-patient clinics or health stations, under the leadership of the chief clinic physician or the director of the health station. The MSS MPVO in the railroad and marine transport industries are similar, although their emergency services are adjusted to the peculiarities and activities of the transportation system.

It should be noted that the whole MSS MPVO structure is keyed to internal district and establishment needs as well as to external support for medical sections of the over-all MPVO system in any given geographic area. To expedite this procedure, the MSS MPVO can requisition the resources of the railroads, marine transport, military garrisons, and other available services. 276/ In the event of an actual air raid, the MSS MPVO operates at the MPVO

- 46 -

S-E-C-R-E-T

Figure 17

ORGANIZATION OF MEDICAL CIVIL DEFENSE IN THE USSR

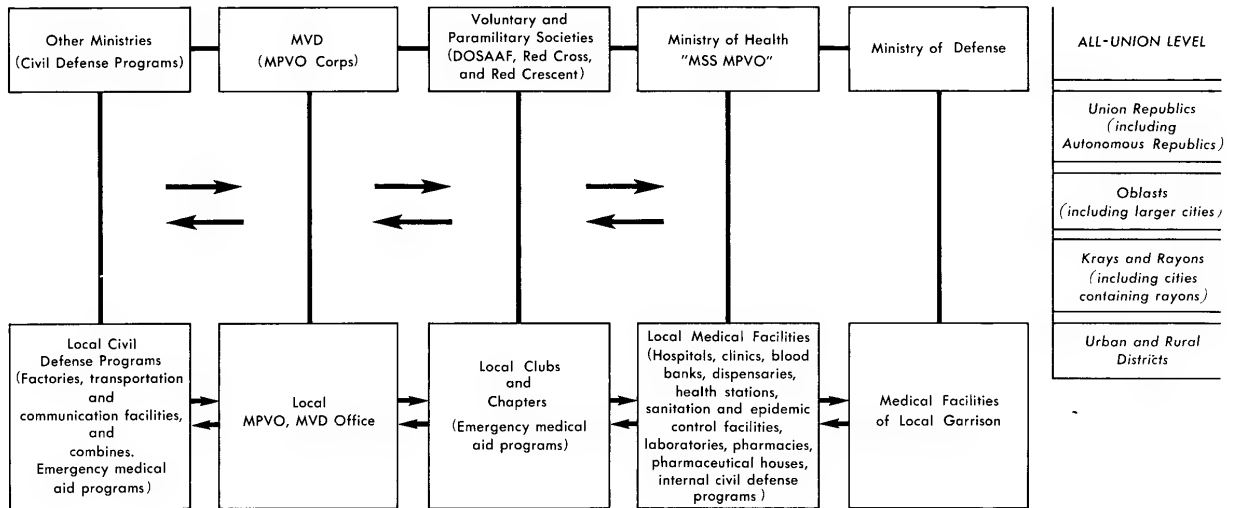

14754 (First Revision 10-56)

50X1

S-E-C-R-E-T

medical establishments outside a given area as well as in the area under attack. This concept of support for target area borders is an outgrowth of Soviet experience in World War II, when the quick availability and utilization of transportation and medical resources made it possible for medical defense units of neighboring cities and rayons to give timely aid to areas where medical facilities were depleted. No special instructions or directives from higher authority are necessary in emergencies such as air raids or states of siege.* Tactical decisions, based on the favorable results of similar arrangements during World War II, are left to local authorities. 277/

a. Missions and Functions.

The following missions are assigned to the MSS MPVO:

(1) The practical administration of all medical institutions located within the limits of a city and their adaptation to the needs of local air defense.

(2) The organization of stationary and mobile facilities for rendering aid to victims, including the following: stationary and mobile first-aid stations; stationary and mobile dressing stations; stationary and mobile clearing stations; stationary and mobile decontamination stations for the decontamination of the clothing of victims of chemical, biological, or radiological warfare; station hospitals; and medicochemical laboratories for the detection and analysis of chemical, biological, or radiological substances in such things as water and foodstuffs.

(3) Furnishing crews and services of the MPVO with medical equipment.

(4) Training and requalifying personnel such as doctors, laboratory workers, nurses, and corpsmen for work in various medical institutions and crews of the MPVO.

(5) Directing military training of all medical institutions, and of MPVO crews which are designed for use in case of enemy air attack.

* For a flow plan of MPVO emergency medical treatment of mass casualties, see Figure 18, following p. 48.

S-E-C-R-E-T

(6) Registering all medical property found in homes, institutions, and business establishments.

(7) Planning and directing the organization and training of the general population (medical units and militia) for medical defense, self defense, and mutual aid. Such work includes the following: first aid and evacuation of the victims of air attack; organization of sanitation squads for the decontamination of areas, clothing, water, and food in case of chemical, biological, or radiological attack; aid stations for those suffering as a result of chemical, biological, or radiological attacks; organization of local defense against air attack within medicosanitary establishments; sanitary and epidemic control measures; and the maintenance of all means of protection and sanitary supervision over collective protection facilities during air raids. 278/

In carrying out its extensive mission, the MSS MPVO uses different types of units, which vary as to personnel and assignment as follows:

(1) Medical Self-Defense Groups.

Medical self-defense groups are trained in first-aid methods and transportation of the injured. They are organized before the outbreak of hostilities at dwellings, industrial establishments, and other enterprises. Red Cross and Red Crescent posts substitute for these groups where they do not exist. The USSR has engaged in training large portions of the Soviet population in medical defense by means of the "Ready for Sanitary Defense" (Gotov k Sanitarnoy Oborone -- GSO) norm. Sanitary posts, sanitary self-defense groups, and sanitary teams at dwellings, enterprises, kolkhozes, and sovkhozes are formed from groups of people who have completed courses under the GSO training program. 279/

(2) MPVO Medical Brigades (Commands).

The MPVO medical brigades are organized at industrial or other enterprises and are composed of employees at each particular installation who are equipped according to a "standard table of equipment." The property of medical MPVO battalions is used only for the purpose for which it is intended. Detachments are equipped and trained at the employees' expense. A brigade may include medical MPVO battalions and companies as well as district and rayon medical druzhiny (teams) of the Red Cross. 280/

50X1

ORGANIZATION
OF MPVO EMERGENCY MEDICAL TREATMENT OF MASS CASUALTIES
IN THE USSR

Figure 18

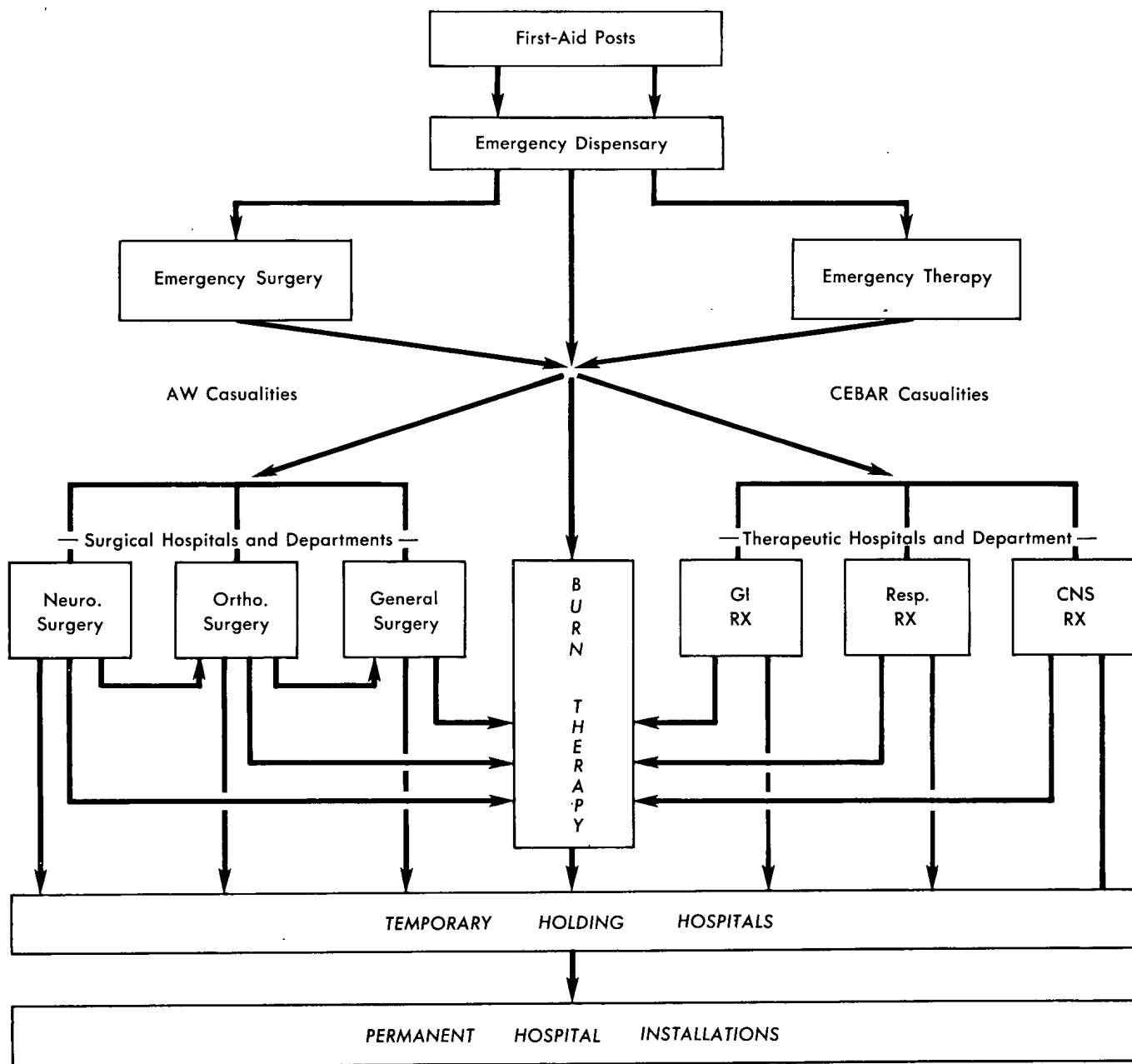

14752

50X1

S-E-C-R-E-T

(3) Red Cross and Red Crescent Societies.

The Red Cross and Red Crescent Societies play a major civil defense role through their sanitary (public health) and first-aid activities, which affect large masses of the population. Their functions include not only a well-developed system of training but also the formation and management of groups which perform particular tasks connected with public health and with sanitary and first-aid aspects of military and civil defense operations. 281/

A federation of the republic societies of the Red Cross (Obshchestvo Krasnogo Kresta -- ROKK) and the Red Crescent (Obshchestvo Krasnogo Polumesyatsa -- OKP), the Union of the Societies of the Red Cross and the Red Crescent (Soyuz Obshchestv Krasnogo Kresta i Krasnogo Polumesyatsa -- SOKKIKP), has operated since 1925 on an All-Union scale. The general aims of SOKKIKP are to strengthen the wartime first-aid capabilities of the population and to assist in improving the hygienic conditions of the civil population. The program devised to attain these aims includes "wartime cooperation with medical units of the army and navy and rendering medical aid to soldiers and civilians injured in military action, peacetime organization of aid to victims of natural catastrophes, assistance to governmental health organs in providing public health service, organization of a network of first aid, training of auxiliary cadres of medical personnel among the youth, and the outfitting of medical aircraft." 282/

Red Cross civil defense teams, or druzhiny, are formed within cities, rayons, transport systems, collective farms, state farms, housing units, factories, and schools. At the present time there are various types of teams with different functions and numbers of members, ranging from 3 to 16. The activities of units of this type are directly related to the needs of the MPVO, where medically trained personnel and the units to which they belong are further trained to function efficiently within the civil defense system. A Red Cross or Red Crescent sanitation team is composed of 3 groups consisting of 5 people each. Each group is provided with equipment similar to that of a sanitary post. The leader of the team has a satchel of the type carried by a fel'dsher (doctor's assistant). The sanitary team is a public organization and is designated by an order number assigned to it. The Red Cross or Red Crescent sanitary teams represent reserves of the city or rayon MSS MPVO and are used according to directions given by the city or rayon staff of the MSS MPVO. In wartime, sanitary teams are used like sanitary posts for giving first aid at focal areas which have been

- 49 -

S-E-C-R-E-T

S-E-C-R-E-T

hit and for transporting the injured. In peacetime they may function in rendering aid at the time of natural disasters or in connection with public gatherings and public works. A medical nurse, a doctor's assistant, or an experienced leader of a sanitary post is appointed as chief of the sanitary team. Although the Soviet press maintained almost complete silence on Red Cross and Red Crescent first-aid training classes for several years after World War II, it has given them considerable attention since 1951. Reports from various republics indicate that the work of the Societies has been reoriented toward civil defense training since the outbreak of war in Korea. 283/

The wide dispersion of the primary units of the Red Cross and Red Crescent Societies enhances their effectiveness in many functions concerned with public health and civil defense. The latest claim of about 20 million or more members is greater than the World War II registration. 284/ The impetus given to these societies simultaneously with the stress on paramilitary defense organization and its prescribed training are indications of the intensified preparation of the Soviet population for defense. The units of the Soviet Red Cross, which are partially trained groups, form a convenient and important part of the MSS MPVO. Although medical and sanitary training is also conducted by the Ministry of Health and by DOSAAF, the Red Cross and Red Crescent Societies are the most important sources of mass medical and sanitary assistance in time of emergency. 285/

(4) First-Aid Detachments.

A first-aid detachment consists of 2 medical nurses; a sanitar (medical assistant); and a physician, who heads the detachment. These detachments operate in the focal area which has been affected or in its immediate vicinity. If necessary, they may engage the help of medical posts and other medical units located at the focal area. MPVO medical manuals published in the 1951-56 period stress first-aid measures to be taken in contingencies such as the destruction of buildings by bombing with resulting injuries to occupants; injuries because of explosion waves; loss of consciousness from all causes; epileptic attacks; burns; poisoning with various substances (alcohol; methanol; ethylene glycol used as antifreeze; strong acids and caustic alkalies; mercuric chloride; morphine; cocaine; phosphorus; toadstools; spoiled fish and other spoiled foodstuffs; industrial poisons including lead, mercury, zinc, hydrogen sulfide, arsenic, benzene, and aniline; and agricultural poisons); and shock resulting from electric current. The treatment of persons who have been

S-E-C-R-E-T

injured by incendiary bombs (for example, burning phosphorus) and chemical, biological, and radiological agents is described in particular detail. 286/

(5) Medical Transport Teams.

Medical transport teams consist of specially designated MPVO transportation units that utilize litters, ambulances, trucks, and reconverted vehicles of various types. 287/

(6) Epidemiological Control Teams.

Epidemiological control teams are responsible for supporting wartime cleanup activities in areas where epidemics have broken out.

(7) Search and Casualty Sorting Teams (RSG).

Search and casualty sorting teams are composed of nurses with special training in casualty rescue and care services.

(8) Student Teams (ORVP).

Student teams are organized at educational institutions in support of the adult program. 288/

b. Use of Facilities.

The plan for medical aid establishments of the MPVO makes use of existing medical facilities to care for the different types of air-raid casualties. The medical aid establishments of the MPVO consist of the following: first-aid stations in out-patient clinics for out-patient treatment, first-aid stations in hospitals and in large out-patient clinics where in-patient treatment is given, bathing stations attached to disinfection units and bath houses, stations for anhydrous disinfection, and medicochemical laboratories attached to hygiene and bacteriological laboratories. Schools, club-houses, motion-picture theaters, institutes, air-raid shelters, cellars, and the like may also be used. Places at which medical aid is given before the injured are treated by a physician include first-aid stations (Punkt Pervoy Meditsinskoy Pomoshchi -- PPM), dispensaries

S-E-C-R-E-T

(Statsionarnyy Punkt Meditsinskoy Pomoshchi -- SPM), and hospitals.* A first-aid station may have only a fel'dsher, who would be located at a midwife station or an ambulatory polyclinic. It gives medical aid to persons suffering from light wounds, traumatic injuries or burns, and exposure to nonpersistent toxic agents. Dispensaries give medical aid to all classes of injured, including those who have been exposed to persistent toxic agents, and they also provide temporary hospitalization inasmuch as they are located at hospitals, sanitariums, and health resorts. The USSR does not consider it necessary to establish a first-aid station at every stopping place along the evacuation route from an area under attack. Air-raid casualties who have been removed from an area are sent to the nearest hospital in the region under attack. All complex medical care is given in one place. Medical aid stations are used mainly as places where rest is given and where victims are sorted. Because of the lack of qualified surgeons in medical aid stations, surgery is necessarily limited to giving first aid and preparing patients for evacuation. If the area under attack is not far from a hospital, casualties are sent directly to the hospital. 289/

One of the most important duties of the MSS MPVO service is to supervise the operation of hospitals under air-raid conditions.** Instructions concerning the training and duties of all hospital personnel have been issued covering alerts, "air attacks of any kind," fires, chemical, biological, and radiological attacks. Hospitals that are situated within the zone of air defense must make provision for the following: protecting patients from bullets, shells, and chemical, biological, and radiological agents, mainly by constructing shelters as well as by providing individual equipment for protection against chemical, biological, and radiological aerosols; providing properly equipped admission wards, where qualified professional medical aid and treatment can be given to victims; taking such general measures as are necessary in case of an air raid, such as blackouts, fire-prevention measures, assignment of duties, and instruction of personnel; drawing up an internal operating plan; and preparing to respond properly to air raids and air alarms. In case of an air attack on the territory served by the hospital, the chief medical officer of the hospital assumes charge of the previously

* Administration of first aid must be confined mainly to the nearest available stations. The need for evacuation is determined later, at stations where more qualified medical service is available.

** For the operation of Soviet blood transfusion services in disaster and wartime situations, see Figure 19, following p. 52.

Figure 19

OPERATION OF SOVIET BLOOD TRANSFUSION SERVICES IN DISASTER AND WARTIME SITUATIONS

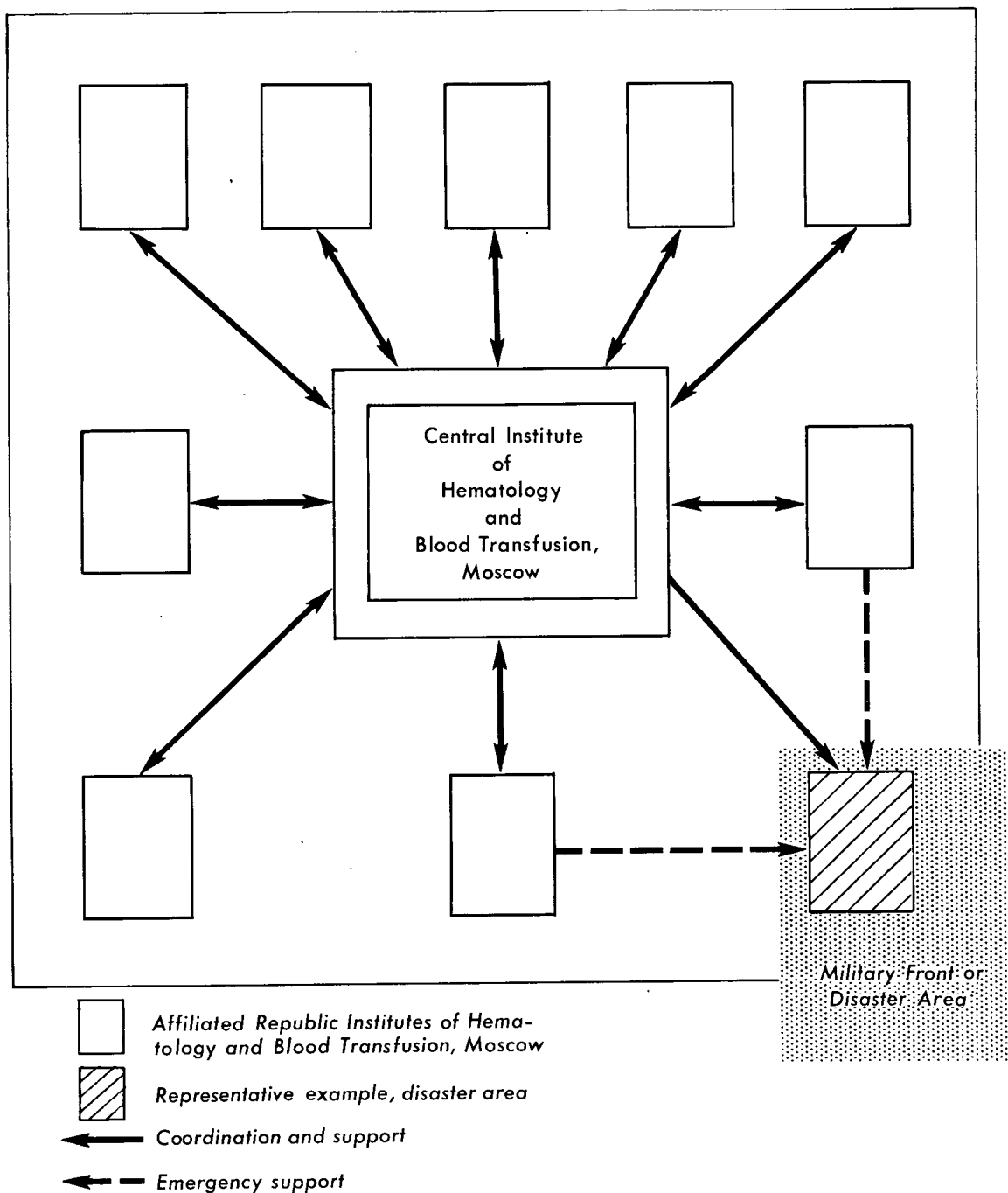

S-E-C-R-E-T

organized staff of MPVO personnel. If the chief medical officer is absent when the alarm is sounded, the individual in charge of the MPVO staff of the hospital takes charge. The medical officer on watch at the reception ward assumes responsibility in case the above two individuals are not available. The duties are decentralized and are distributed among different divisions and buildings of the hospital. In case of an air raid, duties are performed by available personnel using all resources at their disposal.* 290/

Specially adapted hospitals and hospital departments are used for the treatment of the injured. Surgical hospitals or departments are used for the treatment of people who have been exposed to vesicants and thus have skin blisters and ulcers, and also for the neurosurgical treatment of persons suffering from damage to the central and peripheral nervous system. Therapeutic hospitals or departments are used for victims suffering from damage to internal organs caused by exposure to toxic agents which have a suffocating, generally toxic, or irritating effect. Therapeutic treatment must also be given to victims who rapidly exhibit pathological effects in respiratory organs or in the gastrointestinal tract as a result of exposure to persistent toxic agents. Hospitals and other medical institutions located in an MPVO zone must comply with all standard procedures relative to MPVO measures taken at dwellings, such as blackout procedures, protection against fire and structural collapse, prevention of panic, first aid to victims at the site of the institutions, and decontamination of the grounds of the institution. All patients must be equipped with gas masks, and a shelter for the patients must be provided.** The receiving room of a hospital functions as a dispensary.

* For the operational chain of command of Soviet medical civil defense at a target, see Figure 20, following p. 54.

** Under field conditions, MPVO personnel must camouflage carefully the location of the medical establishments. Collective protection for patients is carried out according to the following procedures: (1) dig tents into the ground; (2) construct field-type shelters (trenches or underground shelters); (3) in populated areas, utilize the cellars of buildings; and (4) seal window openings with bricks and sand bags. Medical establishments are provided with shelters. These shelters have beds for patients, rooms where operations can be performed, and apothecary and dressing compartments. Shelters where out-patient treatment is given are provided with the necessary furniture for sitting and resting. Shelters for sick and wounded must

S-E-C-R-E-T

The basic nonmedical manpower pool of a hospital MPVO is the "unitary detail" which is formed from the hospital personnel whose work is not directly connected with taking care of patients. Instructions concerning the training and duties of all hospital personnel have already been issued. 291/ The unitary MPVO detail, composed of hospital workers, is used for the prevention of panic and the repair of damage resulting from an attack. 292/ The detail consists of the following sections: decontamination, fire prevention, medical, preservation of order, and repair of structural damage. It is equipped with all necessary tools and supplies as enumerated in the standard list, including gas masks and protective clothing, fire-fighting equipment, stretchers, helmets, belts with snapping hooks, and building supplies. 293/

Soviet pharmacies and pharmaceutical houses play a vital role under air-raid conditions. Pharmacies supply goods such as drugs and bandages to medical institutions, formations of the MPVO medical service, and the general population. First aid to victims must also be given at pharmacies. Every pharmacy and pharmaceutical enterprise must plan beforehand, and in detail, measures which are to be taken in an emergency, including the following 294/:

- (1) Means for blacking out buildings must be provided; fire-protection and other defense measures must be taken.
- (2) Individual means for protecting employees and decontamination equipment must be provided.
- (3) Arrangements for hermetically sealing the housing of the establishment (including storerooms for supplies and packaging) must be made in order to allow work to continue in case of contamination of the area with chemical, biological, and radiological agents.
- (4) Special teams (posts) must be organized at every workshop and department and must be instructed in the duties to be performed in case of an air alarm.
- (5) Preparation must be made for giving first aid to persons who have been wounded, burned, or exposed to nonpersistent toxic agents.

have sufficient reserves of food and drink. Because chemical substances may be used, special hermetic shelters, properly ventilated with filters and supplied with individual protective equipment, are provided.

Figure 20

OPERATIONAL CHAIN OF COMMAND OF SOVIET MEDICAL CIVIL DEFENSE AT A TARGET

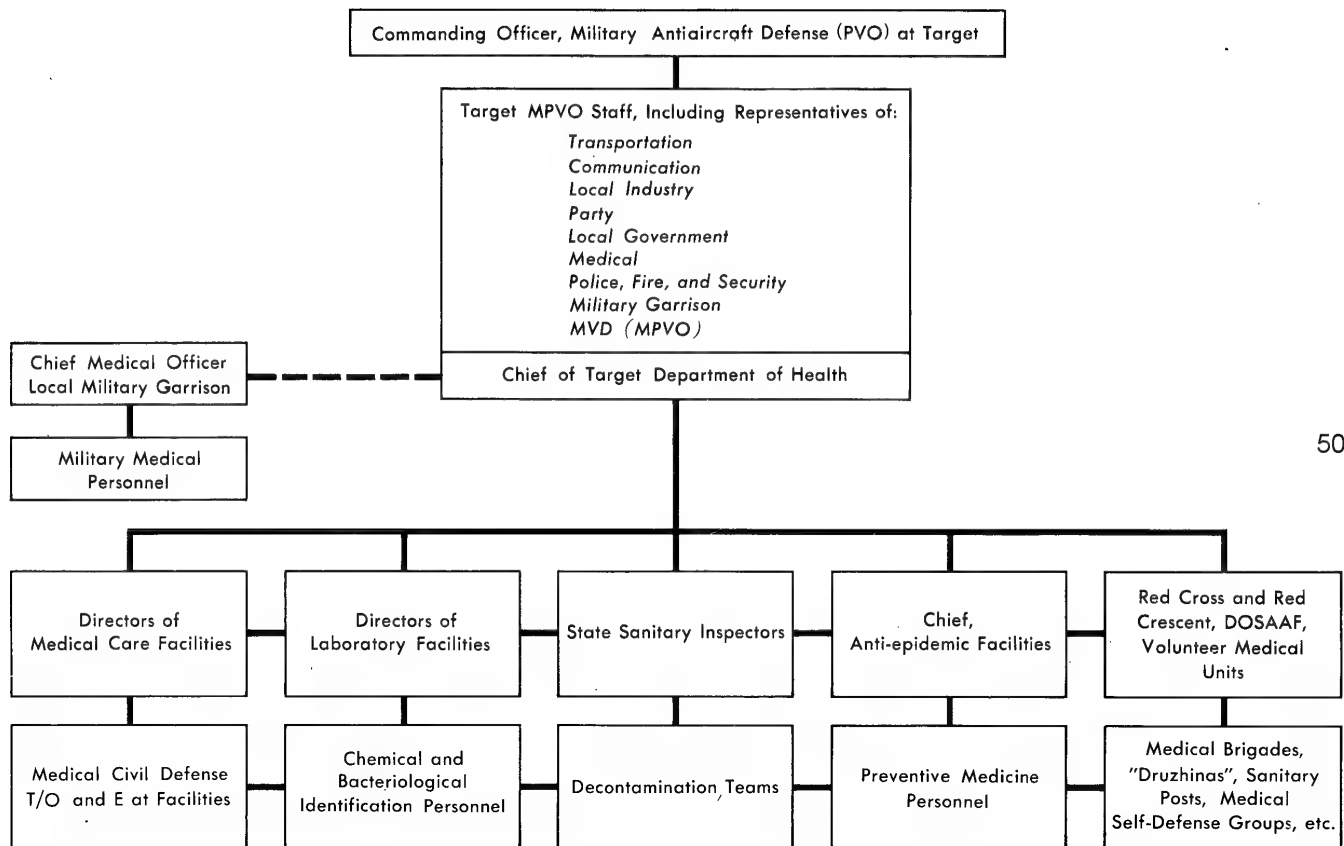

50X1

50X1

S-E-C-R-E-T

(6) Personnel must be trained for MPVO work.

(7) Exhibits are arranged, posters are put up, and literature is distributed in order to familiarize the general population with the measures to be taken for self-aid and mutual aid under conditions requiring the operation of the MPVO.

(8) Political and educational work is carried on among the populace according to a special plan.

Another extremely important problem of the MSS MPVO concerns the measures to be taken for sanitary and epidemic control in work and daily life while expecting an air attack. Crowded conditions in shelters and the possibility of damage to facilities such as kitchens, dining rooms, sources of water supply, water supply lines, and sewer systems create adverse conditions which require special arrangements. The USSR is currently stressing the need for persistent efforts to maintain cleanliness (particularly in shelters), for sanitation supervision, for epidemic control, and for preventive medical measures. These measures are executed by the existing sanitation establishments under the supervision of state inspectors. The chief of state inspection in the city or rayon supervises the activities of the state inspectors and health officers in rayons and industrial establishments. All medical, sanitary, and hygienic organizations are charged with the liquidation of "all sources of infection created by biological warfare, air attack, sabotage, or any other kind of attack." 295/

One of the most complicated problems handled by the sanitation system is the sanitary-chemical appraisal of food products and water and the determination of when an area affected by agents has been completely decontaminated. A network of sanitary-chemical laboratories has been established for that purpose. All laboratories that are already in operation, regardless of their implementation, must be geared to meet emergency situations. Larger laboratories must be able to detect new, unknown chemical, biological, and radiological warfare substances which may be utilized by an enemy. They must ascertain standard methods for identification and decontamination, explain their toxicological properties, and ascertain methods for treating victims. 296/

S-E-C-R-E-T

2. Veterinary Service.

The Veterinary Service (Veterinarnaya Sluzhba) of the city or rayon MPVO is designed to render veterinary assistance to animals under air-raid conditions. The chief of the Veterinary Service of the city or rayon MPVO may be designated by the director of veterinary inspection of the city or rayon, and he is subordinate to the Chief of MPVO.

Recently, civilian veterinary defense activity has been indicated in agricultural establishments as part of the total medical civil defense preparation in the USSR. The organization and functions of the civil defense Veterinary Service apparently have varied very little from similar activities during World War II, 297/ except for a stronger emphasis on defense against special weapons. 298/

The Veterinary Service of the city or rayon MPVO has the following missions:

a. The organization of veterinary help for animals which are the victims of air attack and of their evacuation from stricken areas into safe zones. This mission is assigned to the veterinary crew established by the Veterinary Service and is directly responsible to it.*

b. The procurement of expert advice concerning fodder and other animal food, for which it is necessary to organize enough chemical laboratories and consultation offices.

c. The organization of a sufficient number of stations for veterinary aid and the training of qualified crews to serve in them.

d. The provision of all veterinary stations with equipment and medicine.

e. Training and operational activities relative to amelioration of attack with chemical, biological, and radiological weapons.

* Trained veterinarians are also recognized to be of great value as auxiliary support for the treatment of human casualties.

S-E-C-R-E-T

C. Defense Against Special Weapons.

The first details relative to the current emphasis on readying the Soviet population for defense against chemical, biological, nuclear (and radiological) warfare attack were revealed in 1956. The indoctrination for civil defense workers closely resembles that found in similar military and civil defense manuals recently published in the US. Chemical, biological, and radiological defense planning in the USSR apparently is based upon the Soviet assumption that US-developed chemical, biological, and radiological warfare weapons systems are operationally feasible. Soviet training instructions take for granted the possibility of disseminating bacteria, viruses, toxins, and radioactive materials from planes or by sabotage.

1. Chemical Warfare.

The Soviet population is generally aware of the factors involved in chemical warfare defense. Procedures for medical defense against conventional chemical warfare agents are published and well defined, with specific instructions for the treatment of casualties and the use of available laboratory facilities for chemical warfare agent identification and detection. 299/

The chemical warfare detachments of the MSS MPVO use existing facilities and personnel at the disposal of the city or rayon public health organizations. Public baths serve as decontamination stations in the event of an emergency. Specially adapted dispensary and hospital facilities are used for the treatment of chemical warfare casualties. 300/ It is not believed that the necessary equipment and supplies are maintained by individual stations during peacetime. The extent of implementation of detailed Soviet plans for the distribution of drugs from pharmacies for civil defense purposes is not known.

a. Nerve Gases.

An MPVO manual published in 1954 mentioned the need for protection against nerve gas, specifically Tabun,* but it gave no details on Soviet methods. 301/ Soviet research on the acetylcholine-cholinesterase enzyme system indicates, however, that the

* German term for a nerve gas, adopted by the USSR.

S-E-C-R-E-T

USSR is thoroughly aware of the mechanism of the biochemical and physiological action of nerve gases. A 1956 manual indicates that first aid for a Tabun casualty consists of putting the gas mask on the patient and immediately evacuating him to a hospital; atropine in liquid or powdered form is to be given "if conditions permit." 302/ It is not known whether the present Soviet antigas medical kit includes atropine sulfate, but the USSR is reported to have this drug in quantity. Platyphylline has been developed and manufactured as an atropine substitute by the USSR. Soviet interest in the therapeutic qualities of lobeline hydrochloride has also been shown. 303/

b. MSS MPVO Decontamination Measures.

The following is a list of decontamination measures utilized by the MSS MPVO 304/:

Yperite	10 to 15 percent solution and dichloramine Calcium chloride-calcium hypochlorite moistened with water Calcium hypochlorite
Trichlorotriethylamine	The same as yperite
Lewisite	Iodine infusion 10 percent Lugol's solution 5 percent NaOH solution 10 to 15 percent solution of chloramine or dichloramine Calcium chloride-calcium hypochlorite moistened with water
Phosgene	Alkalis Urotropin Soda Ammonia Polysulfides Hyposulfite
Diphosgene	The same as phosgene
Chlorpicrin	Alcohol solutions of caustic soda Solutions of sodium sulfide

S-E-C-R-E-T

Carbon monoxide	Airing
Hydrogen cyanide	Aqueous solutions of polysulfides Airing
Chloroacetophenone	Strong solutions of sodium carbonate Alcohol solutions of alkalis Sulfides of alkali metals
Bromobenzylcyanide	Alcohol solutions of NaOH Concentrated aqueous or alcohol solutions of alkali metal sulfides
Diphenylchloroarsine	Hydrogen peroxide Ammonia
Adamsite	The same as diphenylchloroarsine

A recent Soviet air defense manual adds the following 305/:

<u>Tabun</u>	Alkali solutions Ammonia
Cyanogen chloride	Airing

2. Biological Warfare.

At the present time, Soviet plans for civil defense against biological warfare attack are largely dependent upon the emergency conversion of public health facilities and upon research on epidemiological, prophylactic, therapeutic, and environmental problems related to diseases of biological warfare importance. The biological warfare defense effort is the responsibility of the antiepidemic services of military, security, and public health agencies and is implemented by the planned availability of pertinent vaccines, antibiotics, and the chemotherapeutics. 306/ The Soviet antiepidemic service has been given a major role in the protection of the population against biological warfare attack. MPVO utilizes the antiepidemic service because of its epidemic control mission, 307/ its link with local civil defense needs, 308/ MVD police support, 309/ and the disposition of its facilities.

S-E-C-R-E-T

A biological warfare identification mission for Soviet public health bacteriological laboratories is included in the stated functions of public health and research laboratories within the MSS MPVO system. 310/ For many years the USSR has stressed research on certain infectious diseases which have biological warfare importance. Soviet medical research and development resources and activities demonstrate a high capability for supporting a biological warfare defense program. 311/ Top-level biological warfare defense planning appears to have been under way for at least 4 years. [REDACTED]

50X1
50X1

50X1

[REDACTED] An MPVO manual published in 1954 gave slight attention to the need for biological warfare defense, although Soviet epidemiological literature has stressed the role of public health controls in case of biological warfare attack. 312/ The most recent MPVO manual (1956), however, includes discussions of potential enemy biological warfare agents,* disease symptoms, immunization, and measures for disinfection and for extermination of insect and animal carriers. The manual also includes general information on detection methods, prophylactic treatment after identification, and quarantine of epidemic areas. 313/ It is probable that mass indoctrination of the general population has not yet gone beyond the establishment of an awareness of the potential military use of pathogenic microorganisms, but steps are evidently being taken to give specific training within the PVKhO norm on biological warfare defense techniques.

a. Detection and Identification.

It is almost certain that Soviet emphasis on the development of certain bacteriological air-sampling devices and techniques is intended for biological warfare defense as well as for limited public health purposes. 314/ One recently developed Soviet device which is useful for military and civil defense purposes has been recommended for widespread use and is already being "mass produced." Another is being given "considerable attention." 315/ Such devices are mentioned in a recent civil defense manual as part of the detection methods needed in case of biological warfare attacks.

* Plague, anthrax, tularemia, brucellosis, glanders, pseudo-glanders, cholera, Q-fever, psittacosis, encephalitis, and smallpox. The information in the manual on biological warfare is admitted to have come from non-Soviet sources.

S-E-C-R-E-T

The USSR is aware of the importance of the rapid isolation and identification of biological warfare pathogens and is stressing the improvement and standardization of diagnostic preparations, selective media, and clinical bacteriological and viral laboratory technique. 316/ Soviet investigators are improving techniques for the rapid isolation and identification of fluid and airborne pathogens, utilizing air sampling, membrane filtration, 317/ microspectroscopy, 318/ phagolytic phenomena, 319/ new selective media, 320/ antibiotic sensitivity, 321/ and microphotography. 322/

Soviet literature indicates that the USSR leads the US in practical exploitation of membrane filtration as an industrial and public health tool. In the USSR, standardized methods for assaying microorganism content by means of membrane filtration began to replace the conventional public health titer method in 1939, became an officially adopted procedure in 1950, and are now reported to be in general use for all types of hydrosol and aerosol assays of public health importance. Several different types of portable equipment utilizing membrane filtration have been developed in the USSR for field collecting and processing of samples, based on methods developed during and after World War II. 323/ Also, it is probable that truck-mounted, mobile bacteriological laboratories are being developed for the Soviet Bloc. 324/

b. Decontamination.

The USSR is developing techniques for the effective decontamination of bacterially contaminated air, vertical and horizontal surfaces, fluids, and materials. Conventional disinfectants are now recommended for civil defense use, but claims for the successful use of ultrasonics and ultrahigh frequencies have been made by certain public health research teams. 325/

c. Prevention and Therapy.

The availability in the USSR of prophylactic vaccines against tularemia, plague, anthrax, and brucellosis combined with the civil defense mission of the antiepidemic network which empowers them to immunize and to impose control measures are important factors in Soviet ability to defend against biological warfare attack. In addition, the development and production of antibiotic and chemotherapeutic preparations to supplement, or to use in the absence of, immunization are being expedited for all domestic diseases of biological warfare importance. 326/

- 61 -

S-E-C-R-E-T

S-E-C-R-E-T

3. Nuclear Warfare.

Medical civil defense training against nuclear weapons in the USSR includes preparations for the care of casualties resulting from hydrogen bombs and radiological warfare weapons. 327/ The USSR is undoubtedly aware that leaving any but token medical staffs and apparatus in the central parts of urban areas is unrealistic, because their destruction would be almost certain and their utility lost. It appears that, along with over-all urban civil defense planning, there is an allocation of medical facilities to target border areas. 328/ Medical civil defense instructions show that casualty care programs are designed to handle mass casualties, 329/ but in the event of a nuclear attack the existing medical preparations would be overburdened.

The available information on training of medical civil defense personnel in the USSR in detection, protection, and care of nuclear warfare casualties indicates no radical departure from methods recommended in the US.

The PAZ training norm is specifically designed for nuclear warfare defense. In addition, the Soviet medical preparations already outlined for conventional and chemical warfare attack are stated by the USSR to be applicable to nuclear warfare problems. The improved pharmaceutical position of the USSR, its well-developed system for whole-blood collection and storage, and research on blood substitutes also indirectly increase the Soviet capability for handling mass casualties. Furthermore, the present Soviet research effort on effects of ionizing radiation (dosimetry, biological mechanisms underlying the radiation syndrome, methods for restoration of irradiated organisms, and mechanisms underlying burn damage) is undoubtedly helping the USSR to deal with radiation hazards. 330/ At present, only well-known detection and care techniques are recommended for civil defense use in the USSR. 331/

VII. Chronology of Civil Defense in the USSR.*

The USSR has embarked on a serious effort to develop civil defense. Definite measures to accelerate civil defense preparations were taken

* See Appendix A.

S-E-C-R-E-T

in 1949, and there has been an increase in emphasis up to the present time with no evidence of a slackening in preparations for passive air defense.

A. 1948.

There are some indications that action was taken in the USSR in 1948 to remedy a postwar slackening in civil defense. It was reported that plans in 1948 envisioned the training of 4 million to 5 million persons per year in PVKhO. 332/ Open publications announced that 15-day training courses had been given in one area for leaders of self-defense groups from factories, schools, dwellings, and the like. 333/

B. 1949-50.

Early in 1949 the sanitary epidemiological service was reformed. 334/ This service is connected with a chief directorate of the Ministry of Health, which has been reported to be the highest organ on all matters of preparations for defense against biological warfare attack. 335/ It was also in 1949 that the Soviet government made the decision to complete the basic radiofication of the country by 1955, 336/ a decision which may have been related to a civil defense warning system.

The preparation of air-raid shelters was initiated by 1949, 337/ probably as the result of a governmental decision. An unconfirmed report fixes the beginning of air-raid defense training for factory workers in July 1949, 338/ and a small-scale decontamination exercise was reported to have occurred in Moscow in September 1949. 339/ In the spring of 1950 it was again reported that the USSR had initiated a program to give basic civil defense training to 5 million citizens a year. 340/ Preparatory rather than general training was apparently the goal at that time because the 1950 plan called for enlistment of "tens of thousands" of instructors for air defense training. 341/

C. 1951-52.

Training in local air defense was stressed during this period. In September 1951 the three existing paramilitary societies were consolidated as DOSAAF, 342/ dues were reduced, and the minimum age lowered. Shortly thereafter it was announced that civil defense training was a vital part of the organization's activity, and it was urged that PVKhO study groups be formed in every enterprise, collective

S-E-C-R-E-T

farm, machine tractor station, institution, school, and large residential building. 343/ At least three manuals of instruction were published for the general population 344/ as well as manuals for internal DOSAAF use. 345/ In March 1952 it was revealed that PVKhO study groups had become compulsory in all primary organizations of DOSAAF. A decision was adopted by a plenum of the Komsomol Central Committee requiring every Komsomol member to join DOSAAF, 346/ and an appeal was made for members of trade unions to join. 347/ An indication of desired DOSAAF activity in plants during this period was given in the announcement that 4,000 workers of the Elektrosila Works in Leningrad were DOSAAF members and that 1,500 had passed the tests "Ready for Air and Chemical Defense." 348/

The Soviet GP-4 gas mask was probably being manufactured in quantity by 1952. 349/

D. 1953-54.

There is reason to believe that civil defense in the USSR received an added impetus during 1953. It may have resulted from a decision made at the XIXth Party Congress in October 1952 to develop an all-out defense of the USSR against any aggression. 350/

DOSAAF had only limited success in 1951 and 1952, and in the early months of 1953 it was the object of a critical press campaign. 351/ This criticism ended with the appearance of a new chairman of DOSAAF who quickly took measures to enlarge the membership of DOSAAF and improve PVKhO training. A DOSAAF membership campaign was instituted which culminated in the first All-Union Conference of DOSAAF in December 1953. 352/ PVKhO training became compulsory for all members of the society who had reached the age of 16, with re-training required every 2 years. 353/ Komsomol activity in DOSAAF was again stressed, and joint meetings of Komsomol and DOSAAF groups were noted. 354/ Training in economic enterprises was still emphasized, and [redacted] 60 percent of the port workers in Tallinn were "more or less forcibly" enrolled in DOSAAF and that 90 percent of the port workers had taken short courses in air defense by May 1953. 355/ A plenary session of the DOSAAF Central Committee was called with attendance of all chairmen of the republic, kray, and oblast committees for 31 July 1954. 356/ (Bylaws would not have required the meeting before December.) Meeting at the same time in Bulgaria was an inter-Satellite conference of DOSAAF-type organizations which was attended by DOSAAF

50X1

- 64 -

S-E-C-R-E-T

S-E-C-R-E-T

representatives. The timing of the Bulgarian meeting suggests that it was for the purpose of issuing coordinated instructions, possibly on the handling of atomic defense instructions. 357/ On 31 August 1954, Pravda carried a DOSAAF article indicating that the priority goal of DOSAAF was the training of "all" the population in "modern" PVKhO.

E. 1955-56.

During 1955, pressure continued on DOSAAF to improve organization and recruitment. A new DOSAAF chairman appeared -- Guards Colonel General P.A. Belov, a war hero and former military district commander. Reserve personnel were extensively enlisted for DOSAAF work. DOSAAF was made responsible for organizing "self-defense" groups in addition to training them. Training was modified to include instruction against biological warfare and atomic weapons.

During 1956 the preparation for atomic defense was stressed, including reorganization of operative civil defense units and retraining of operating personnel and the population. 358/ Protective construction was continued. 359/

VIII. Civil Defense Against Nuclear Weapons.

The USSR refrained from describing the hazards of nuclear warfare in open publications until 1954. Release of such information occurred shortly after classified manuals on the subject were disseminated to Soviet troops in the fall of 1953. 360/

A series of articles in Krasnaya zvezda, which started in January 1954 and ran through most of the year, discussed the physics of nuclear forces, dangers from an atomic explosion, atomic defense for troops, and peaceful uses for atomic energy. 361/ Although this newspaper is published for the military forces, it is an open publication available to civilians as well. Some of the material appears to have been copied from US publications. Accompanying the articles were Soviet broadcasts on the same subject, but these were also directed principally to the armed forces. 362/

Instructions for atomic defense for civilians were occasionally reported between 1947 and 1954 but were generally given only to selected personnel. 363/ DOSAAF manuals of 1951 and 1952 on civil defense omitted mention of nuclear warfare. A manual published in

S-E-C-R-E-T

1954, 364/ however, made note of atomic bombs and their use in World War II by "American imperialists." On 31 August 1954, a first-page editorial in Pravda referred to the preparation of the population for "modern" air defense -- the unusual insertion of "modern" presumably referred to atomic defense. On 17 September 1954, in announcing new Soviet atomic tests, Tass and Izvestiya stated that the solution of problems of defense against atomic attack would be solved with the help of information gained in the tests. Instruction on atomic defense started on a high level. A lecture for intelligentsia was given in one region in November 1954 on "Atomic Attack and the Defense Against It." 365/

Soviet civil defense preparations and instructions before 1955 were ostensibly directed against what are usually termed conventional weapons of air attack.* Beginning in June of that year, however, it became progressively apparent that civil defense activity was being intensified and modified to include protective measures against atomic if not thermonuclear weapons. A DOSAAF publication stated that the training norm for PVKhO would henceforth include familiarization with and means of protection against atomic and bacteriological weapons and incendiaries of the napalm type. Training for instructors was stressed in the article, giving the impression that this type of training was in its early stages. 366/ Komsomol'skaya pravda, in July 1955, contained an article on decontamination procedures to be followed in a populated area after an atomic explosion. 367/ Similar articles related to modern weapons have continued to appear in Soviet periodicals, and numbers of training manuals were published during 1955 and 1956. 368/

The year 1956 has been marked by several pronouncements by Soviet leaders emphasizing the need for improved civil defense. Articles in a new Soviet newspaper, Sovetskiy patriot, are publicizing Soviet civil defense to increase public awareness of the threat of modern weapons and to facilitate recruitment of civil defense workers. In an important article for the newspaper, Marshal Semyen Budennyy declared that the home front defense problem had grown immeasurably and that atomic and chemical defense training now directly concerned every Soviet citizen. 369/

* High explosives, incendiaries of the thermite type, and war gases generally known before World War II.

S-E-C-R-E-T

The appearance of this paper followed Marshal Zhukov's call for increased emphasis on civil defense in his speech to the XXth Party Congress. 370/ Before this, the commander of the Kiev Military District had said that assistance should be given to civil defense units in "reorganizing their activities in accordance with present day requirements." 371/ At the present time, compulsory civil defense courses are probably being given to the Soviet population, accenting defense against atomic weapons. 372/

Soviet civil defense plans for protection against nuclear attack, aside from matters of public information, are unlikely to become available outside the USSR. Some of the measures already taken for civil defense as well as published articles are worthy of examination for their possible uses in nuclear defense of the general population.

It has already been noted that the USSR has a considerable program under way for the inclusion of shelters in all new buildings.* The Krasnaya zvezda articles on atomic bombs stated that there are reliable means and methods of defense against them. Repeatedly mentioning blast effect as the major hazard of nuclear warfare, the use of ground cover, trenches, and prepared shelters was urged as the principal means of reducing casualties. Noting World War II experience, the articles stressed the fact that cellar shelters in urban areas with reinforced or arched concrete ceilings are protected from the major blast effect, which is dissipated on the upper stories. This approach is consistent with known shelter design in the USSR, which includes a cellar ceiling design to withstand the complete collapse of the building. 373/ DOSAAF instructions of 1956 as well as published articles reassure the Soviet citizen that basement-type air-raid shelters provide "safe protection" against atomic weapons. 374/ Heavier and gallery-type shelters are also mentioned. Information on massive deep-level shelters is inconclusive, except for that on subways, but such shelters probably exist for government installations. No reference is known to a mass evacuation plan for urban areas, but this lack of evidence does not prove that none has been prepared. There have been no evacuation drills reported.

The recommendations for protection against light as given in a Soviet military handbook are shielding the face, lying down, or taking cover. 375/ For defense against fire, the military envisaged

* See IV, p. 27, above.

S-E-C-R-E-T

organization of fire-fighting details within troop units, provision of equipment for combating fire, and various fire-prevention measures such as cutting clearings, plowing, and removing inflammables from troop areas. 376/ Civil defense instructions suggest improved fire-prevention measures and the preparation of auxiliary water sources for fire fighting. 377/

For protection against radioactivity, standard gas alarm signals and reconnaissance to detect and combat radioactive elements are to be used. 378/ Markings are to be used for contaminated areas and for passages through them. Individual protective measures recommended are the use of gas-protective clothing and gas masks. 379/ Filter ventilating systems in Soviet air-raid shelters presumably would be used with the same effect as gas masks.

According to instructions, decontamination of an area from radioactive material is to be accomplished by (1) clearing passageways, (2) decontaminating structures and installations urgently needed, and (3) decontaminating the remainder of the area and buildings and their contents. 380/ Physical means of decontamination are used such as burying or actual removal. Persons leaving areas of radioactivity are to undergo physical decontamination of themselves and their clothing, checked by using instruments for measuring radioactivity. 381/

Atomic defense in the USSR is being superimposed on the existing civil defense structure. The use of cellar shelters, although admittedly not entirely effective, should reduce casualties in areas removed from "ground zero." These prepared shelters have the advantages of provision for gas defense and quick accessibility. Headquarters, public building, factory, and subway shelters might further reduce casualties.

Most information published in the USSR regarding nuclear weapons has emphasized or described only atomic weapons of nominal size. The public therefore is probably unaware of the magnitude of destruction possible with the larger thermonuclear weapons and the limited protection which would be afforded by the basement-type or similar air-raid shelters. Evacuation or dispersal has not been publicized, and it appears evident that, at the present time, civil defense for the general public is committed to the use of locally available shelters.

It is worthy of note, however, that the USSR is well aware of the power of larger weapons and that theoretical articles have been

S-E-C-R-E-T

published which would lead to the conclusion that defense would be improved by some use of dispersed suburban shelters. 382/ Dispersal of civil defense units (fire and emergency engineering units) has been specified as atomic defense policy in Soviet publications. 383/ One article states that civil defense fire-fighting crews and equipment are to be placed in shelters near main roads on the outskirts of populated areas. 384/ It is highly probable that dispersed locations for important government offices have already been prepared. 385/

IX. Civil Defense in the European Satellites.

Development of civil defense in the European Satellites has been especially substantial in Czechoslovakia, Hungary, and Bulgaria and recently in Poland. [redacted]

50X1
50X1

[redacted] civil defense is supervised by Soviet officials and modeled on the Soviet pattern. 386/

A. Albania.

Little is known of civil defense in Albania. A DOSAAF-type body, the Society for Aid to the Army and Defense (Shoqeria per Ndihme Ushtrise Dhe Mbrojtje -- SHNUM), reportedly is concerned with paramilitary, civil defense, radio, and first-aid training. 387/ Units of this organization are reported widely present in state institutions, enterprises, ministries, and cooperatives. 388/ Its members are trained to fill civil defense assignments in time of war. 389/ [redacted] the organization has trained 31,000 "civilian specialists," but some of these are probably for purely military purposes. 390/ The Albanian Red Cross claims to have trained 44,500 for the award, "Ready for the Protection of Health," 391/ which is probably similar to civil defense first-aid courses in other Soviet Bloc countries.

50X1

B. Bulgaria.

Bulgaria has been particularly active in civil defense preparations. Reconditioning of World War II air-raid shelters as well as new construction started in 1950, 392/ and it has been reported that concrete observation posts are being built on large new buildings in Sofia. 393/ An organization similar to the Soviet MPVO is charged with home defense. 394/ The Voluntary Organization for Defense Cooperation (Dobrovolna Organizatsiya za Sudeystviye na

- 69 -

S-E-C-R-E-T

S-E-C-R-E-T

Otbrana -- DOSO) has been very active. First formed in January 1951, 395/ its activities and development closely parallel those of DOSAAF. DOSO membership is estimated at 900,000 396/ and DOSO clubs have been reported to be present in factories and enterprises. 397/ In 1952 the Central Council of DOSO organized courses for the training of civil defense instructors, who were to come from factories, enterprises, and collective farms. 398/ Civil defense has been under growing pressure to increase membership. 399/ [redacted] in June 1954 all members of the Communist Party and its youth organization also belonged to DOSO. 400/ Volunteers here, as in the USSR, appear to have been pressed into service. Air-raid sirens are in place and have been tested in the capital. 401/ Attendance at civil defense courses for the general population, which include first-aid courses given by the Bulgarian Red Cross, 402/ is reported to have been compulsory in 1953-55. 403/

50X1

The most noteworthy aspect of civil defense in Bulgaria has been [redacted] various types of shelter construction. For example, Sofia is reported to have a network of air-raid shelters prepared both in the city and in the foothills to the north and south of the city.* 404/ [redacted] intensive shelter construction through 1955, including suburban shelters, galleries in hillsides, and basement shelters. 405/

50X1

50X1

Atomic defense training was reported in Bulgaria in 1953, 406/ and [redacted] such training is under way, probably through the DOSO program. 407/

50X1

C. Czechoslovakia.

Civil defense (Civilni Obrana -- CO) in Czechoslovakia is under the jurisdiction of the Ministry of the Interior 408/ and is well developed according to the Soviet pattern. It includes the organization of civil defense battalions. 409/ It is not known whether these battalions are more than skeleton organizations for cities, but [redacted] [redacted] troops of engineers and "chemists." Civil defense organization and training are well advanced in factories, and commanders of civil defense appeared in early 1954. 410/

50X1
50X1

* For the locations of suburban air-raid shelters reported near Sofia, see Figure 21, following p. 70.

Page Denied

S-E-C-R-E-T

Plant defense in Czechoslovakia apparently has received priority. Increased guard forces, factory fire crews, sirens, and fire equipment, as well as blackout preparations, date from 1949-51. 411/ a description of the defense organization in a Czechoslovak textile plant in 1953, in which there were about 200 workers enlisted for civil defense. A practice drill, started by a blast on the plant siren, included simulated fire, first-aid teams with litters, and a group wearing full gas-protective clothing going through what probably were decontamination procedures. In the spring of 1953, 200 gas masks were received at the plant, reportedly for civil defense crews. 412/ Plants throughout the country have civil defense bodies organized into antichemical, fire-fighting, first-aid, and repair teams. 413/ Uniforms and gas masks have been issued for civil defense personnel. 414/

50X1
50X1

Air-raid shelters were ordered for Czechoslovak plants in 1949, and implementation starting in 1951. 415/ A defector, who was an engineering designer, reported that "Class 2" shelters were being built in plants in 1953. 416/ "Class 1" shelters and shelters for the "commander" had special planning groups, but their locations were not known to the source. Apartment shelters in new buildings* 417/ and central shelters in urban areas have been reported.** 418/ The most recent development in shelter construction has been the initiation of shelters in Danube ports for personnel connected with river shipping. 419/

50X1

The Union for Cooperation with the Army (Svaz pro Spolupraci s Armadou -- SVAZARM), the paramilitary body in Czechoslovakia, has been the object of much attention and publicity since its reorganization in 1952. 420/ It has been particularly active since 1953 under the chairmanship of Lieutenant General Cenek Hruska, who is a member of the Party Central Committee 421/ and a Deputy Minister of Defense. 422/ Bodies allied with SVAZARM in mid-1953 for civil defense training were the National Front, the firemen, the Youth Union, and the trade unions. Civil defense was charged at the same time with centralizing and channeling the activity of the Red Cross, the fire-fighting forces, and SVAZARM. Local administrations were cautioned in August 1953 to follow the plans to establish a strong civil defense "even before concluding the harvest." 423/

* For a photograph of a basement air-raid shelter under construction in Czechoslovakia, see Figure 22, following p. 72.

** For a photograph of the entrance to a reported air-raid shelter in Brno, see Figure 23, following p. 72.

- 71 -

S-E-C-R-E-T

S-E-C-R-E-T

Civil defense training has been widespread in Czechoslovakia. Probably initiated in 1952, the courses were generally compulsory, being widely organized by 1953. 424/ Fines were reported for non-attendance, 425/ and courses included first aid, fire defense, and defense against air attack. [redacted] the training of 130,000 instructors in 1953. 426/ [redacted]

50X1
50X1
50X1

In 1953, Czechoslovakia was negotiating the purchase of 300 tons of activated charcoal "for masks," which would be sufficient for 1 million gas masks on the basis of 200 grams per mask. 428/

D. East Germany. 429/

East Germany is the last important European Satellite to take steps to formalize civil defense organization and training. [redacted] the East German government plans to train the civilian population in defensive tactics against aerial, atomic, and chemical attack. A new office in the Ministry of the Interior has been created for this purpose.

50X1
50X1

The formation of this administration, a logical step at this time, follows the organization during 1954 and 1955 of several activities generally described as "catastrophe" work. There have been specific references to training for catastrophe work in an enterprise, the organization of the Central Catastrophe Aid Service of the East German Red Cross, and the appearance of Catastrophe Sections in city fire departments.

The formation of Kampfgruppen (combat groups) among factory workers is generally well known. These paramilitary groups of trusted workers are charged with the defense of the installation and are trained to put down riots. In addition, they are trained for fire fighting, emergency bridge building, and first aid -- valuable training for civil defense in case of air attack.

Special steps have been taken to prepare the fire-fighting services for civil defense. [redacted]

50X1
50X1

[redacted] It was recently reported that the Ministry of

50X1



50X1



Figure 22

**BASEMENT AIR-RAID SHELTER UNDER CONSTRUCTION,
Czechoslovakia**

24360 j



50X1

50X1

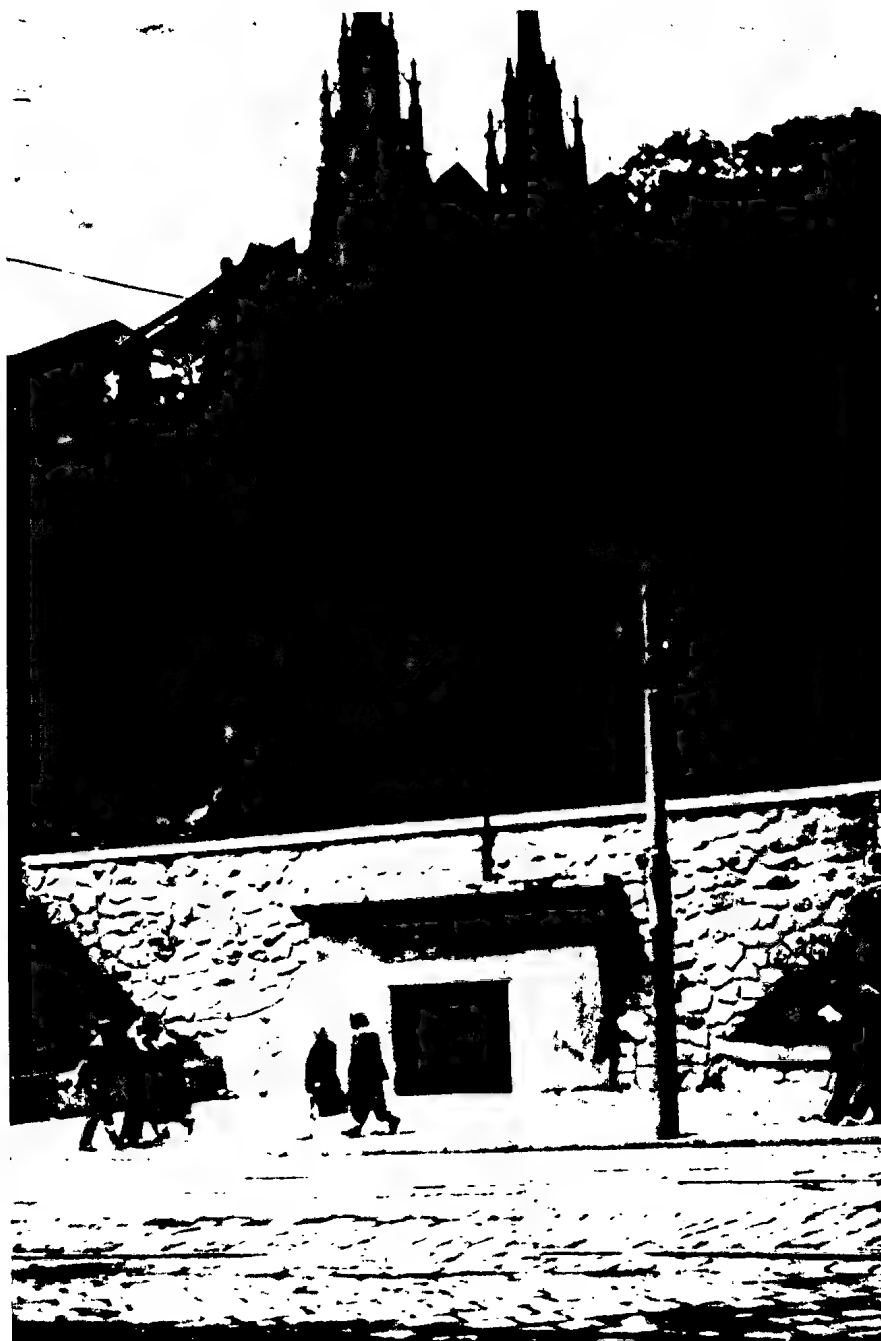

Figure 23
ENTRANCE TO A REPORTED AIR-RAID SHELTER
Brno, Czechoslovakia

24360 k

50X1

S-E-C-R-E-T

the Interior has ordered police units in all cities with more than 10,000 inhabitants to organize a fire-fighting detail for emergency cases (Katastrophenloeschzug), a construction detail with special engineering equipment, and a special technical detail (possibly a bomb disposal unit). These are to be attached to existing fire departments.

German fire fighters have considerable knowledge of large-scale fire fighting based on World War II experience. There is mutual assistance between cities for combating large fires. Small trailer-mounted fire pumps equipped with short ladders and hand tools are being manufactured. This equipment should be of substantial value in war operations, when larger fire trucks are not easily maneuverable in operating over rough terrain and through rubble-strewn streets.

Probably in preparation for medical civil defense, the East German Red Cross has become more active. It recruits and gives first-aid training in East German factories. In November 1954 the East German Red Cross joined the League of Red Cross Societies. Plans were announced in 1954 for an increased membership drive and the establishment of 1,000 new first-aid stations. A Red Cross Central Catastrophe Aid Service has been organized, utilizing the 300 existing first-aid stations and 1,490 ambulances.

Destruction of World War II air-raid shelters has apparently stopped. Cleaning of old shelters as well as some new construction has been reported. Since 1953, provision of new shelters has occurred chiefly in police buildings and factories. It has been reported, however, that the general inclusion of air-raid shelters in all new buildings was ordered in May 1955, 430/ and extensive underground construction has been reported during 1955 and 1956.

Classes in atomic defense training have been held for troop and police units and party groups. Some of the lecturers for these classes were Soviet trained. In East Germany, as in other Soviet Bloc countries, no information is available on defense training or preparation against the larger thermonuclear weapons.

The existence of "alert plans" has been reported for units of the Society for Sport and Technique,* for motor transport, for plant

* An organization similar to DOSAAF.

S-E-C-R-E-T

combat groups, and for the Red Cross Central Catastrophe Aid Service, all of which are expected to take part in civil defense. The first alert stage probably occurs upon a declaration of martial law or a state of emergency. 431/ Preparatory activities carried out during the last 2 years, together with substantial wartime experience, should facilitate a rapid rise in civil defense capability in East Germany.

E. Hungary.

Civil defense in Hungary has been active since 1951, 432/ when shelters were ordered to be reconditioned and attics to be cleared of combustibles. 433/ The civil defense organization is reported to be subordinate to the Ministry of the Interior. 434/ City headquarters of air defense have subdivisions for financing and supply, medical defense, rescue, fire fighting, decontamination, and the like. As in the USSR, major industrial plants are under a different command, and all are subordinated to the Territorial Air Defense Headquarters. 435/

It was decided to construct the Budapest subway in 1950. 436/ Construction slowed down in 1954, but at least two stations have been completed and could probably serve as shelters. An underground communications center exists under Gellert Hill in Budapest. Other government and headquarters shelters were ordered to be prepared in 1951. 437/ in March 1952, one factory had an order for 50,000 doors for air-raid shelters. 438/ The building of factory shelters probably has progressed well in economic installations because these were to be constructed in accordance with "general regulations." 439/ A survey made in 1952 in one plant led to an order for the construction of a 500-person shelter. 440/ It has been reported that shelters in railroad station areas are complete 441/ and that certain communications buildings were to be made splinterproof during 1955-56. 442/

50X1

50X1

The paramilitary body in Hungary is the Hungarian Voluntary National Defense Federation (Magyar Onkentes Honvedelmi Szovetseg -- MOHSZ). 443/

Training in civil defense has been rapid. Starting in 1951, first aid, fire fighting, and air defense training were emphasized. 444/ In 1952, compulsory courses were given in Budapest with fines for

S-E-C-R-E-T

nonattendance. In buildings, trustees were appointed, and "air-raid groups" were formed. 445/ Instructions of this period assume that cellar shelters would be available. 446/ In 1953, training of instructors and workers was reported, including the usual basic courses and final examinations. A semiannual drill, lasting 10 minutes, was reported in one installation. 447/ At the beginning of 1954, instructions were issued to resume the courses with increased fines for failure to appear. 448/

Significant developments in Hungary have included civil defense schools and the appearance of uniformed civil defense "troops." An advanced technical course in air defense for selected government employees is reported to include instruction in city planning, construction of several types of air-raid shelters, camouflage methods, and preventive technical measures. The latter includes such topics as water reserves and the preparation of alternate power lines. 449/ Another civil defense school has been publicized in a Hungarian periodical, with students conducting an exercise in shoring the wall of a damaged building. 450/ Western embassy personnel have observed uniformed troops conducting civil defense exercises. 451/ The Hungarian Red Cross has been connected with first-aid training for civil defense as well as with a blood-procurement program. 452/

50X1

F. Poland.

Poland accelerated preparations for air defense during 1953 and 1954. Although generally considered to be lagging behind Czechoslovakia, Hungary, and Bulgaria, Poland has taken measures to spur the development of civil defense. It was announced in May 1953 that the League of Soldiers' Friends (Liga Przyjaciol Zolnierza -- LPZ), guided by the Communist Party and profiting from the rich experience of DOSAAF, would disseminate defense information among the general population. 453/ In March 1954, LPZ held a national conference in Krakow at which it claimed substantial gains in membership. 454/ A central training school of the organization, which gives 3-month courses for local LPZ secretaries and training inspectors, has been identified. Training of instructors of Local Air Defense (Terenowa Obrona Przeciwlotnicza -- TOPL) began as early as September 1953. The instructors in training appear to be largely selected from factories and institutions and presumably will return to instruct workers in air defense measures. 455/

- 75 -

S-E-C-R-E-T

S-E-C-R-E-T

[redacted] training for air defense in industrial enterprises is beginning, particularly in the Gdansk shipyard. Plans include the training of teams in first aid, rescue work, and air defense. Factory activities, formerly conducted in part by Service for Poland (Sluzba Polska -- SP), were absorbed on 1 May 1954 by LPZ in order to avoid duplication of effort. Aid is to be rendered by the Health Service, presumably in first-aid training. 456/ Factories have been fitting blackout curtains. 457/

50X1

Fire services have been very active in Poland. A government directive dated 15 June 1954 has made all men aged 18 to 60 and all women aged 18 to 50 liable for fire-fighting duty. 458/ In early 1954, fire-fighting teams in industrial establishments were more widely established on a permanent basis, and it appears that training for fire service by auxiliaries is also compulsory in plants and buildings. 459/ The week of 7 June 1954 was designated as the All-Polish Fire Service Week, with the purpose of popularizing the importance of the fire services and mobilizing all men in town and country for the prevention of fires. 460/ It was reported in 1949 that Polish fire services were already efficient and well equipped, partly with imports. 461/

Medical activity applicable to civil defense in Poland includes the Red Cross, with a membership of over 2 million persons. 462/ It has been active in disseminating first-aid instruction. The Ministry of Health maintains a Sanitary Antiepidemic Service which has been active through its agencies in maintaining factory first-aid stations, in popularizing hygiene, and in administering preventive inoculations on a wide scale. 463/ [redacted] penicillin is being held in the reserve stocks of hospitals for the Ministry of Defense. 464/

50X1
50X1

Air-raid shelters are also receiving attention. World War II shelters have been ordered cleaned in Warsaw. 465/ [redacted] the new Warsaw subway, on which work has apparently slowed down, is intended to be used as an air-raid shelter as well as a subway. The plans for the Palace of Culture and Art in Warsaw include massive shelters. 467/ [redacted] the repair and overhaul of World War II shelters was to have been started in the summer of 1954. 468/

50X1
50X1

50X1

- 76 -

S-E-C-R-E-T

S-E-C-R-E-T

[redacted] extensive civil defense training in 1954 in Lodz, where an air-raid drill is reported to have taken place in the central section of the city in December 1954. 469/ Conducting an air-raid drill, even on a sector basis, emphasizes the progress of civil defense in Poland.

50X1

G. Rumania.

Rumanian civil defense has received increased attention since 1954, when it became apparent that training, organization, and protective construction were being accelerated. The paramilitary counterpart of the Soviet DOSAAF, which plays a leading role in civil defense of the USSR, was organized at about the same time.

A civil defense decree was issued in 1950 in Rumania making the Ministry of the Interior the responsible body for developing civil defense. Coordination with the Ministry of Defense and with local government was provided. Civil defense training and service were made compulsory for all Rumanians between the ages of 16 and 60. 470/

The civil defense organization is known as Local Anti-Air Defense (Apararea Locala Antiaeriana -- ALA), which reportedly has a nucleus of specially trained police officers similar to the MPVO corps in the USSR. 471/ Headquarters have been established in Bucharest and its eight subordinate sectors, and it is presumed that similar civil defense headquarters exist in other principal cities. 472/ It has been reported that civil defense groups have been organized in residential areas, factories, offices, and schools since mid-1954. 473/

Factory civil defense instructors and Communist Party members apparently were the first to receive training. Civil defense group instruction is evidently now going on, particularly in factories. 474/ [redacted] this was seriously initiated in 1954. Subjects of instruction have included gas and fire defense, first aid, control and security measures, construction of air-raid shelters, and particular duties for individual members of civil defense groups. 475/

50X1

The paramilitary body, Voluntary Association to Support the Defense of the Fatherland (Asociatia Voluntara Pentru Sprijinirea Apararii Patriei -- AVSAP), was apparently reorganized in mid-1954 476/ and is developing into a counterpart of DOSAAF under Soviet leadership. 477/ Its activities include communications and driver training,

- 77 -

S-E-C-R-E-T

S-E-C-R-E-T

both of which will be available for participants in the civil defense program.

Civil defense instructions in Rumania have assumed that gas-proof air-raid shelters will be available. 478/ Air-raid shelters have been reported under construction since 1953, particularly in and near Bucharest 479/ and in factory areas. 480/* Other construction measures taken include the installation of sirens and the preparation of wells and static water reservoirs. 481/ Reports have not been received of the construction of basement-type air-raid shelters in residential areas, but dwelling unit caretakers are said to have been asked in 1955 to report on the availability of shelter and possibility of adapting cellars to air defense needs. 482/

Medical defense will presumably rely for auxiliary personnel on the efforts of the Rumanian Red Cross, which claims to have trained 600,000 persons in various courses. 483/ First-aid training has been in progress since 1953, and urban women are now being compelled to attend first-aid courses. 484/ Blood banks and blood centers have been established by the Red Cross, 485/ and the supply of blood plasma has been reported sufficient for peacetime requirements. 486/ Stockpiles of medical supplies were reportedly held in areas outside cities under the control of the Commission of Reserves, in 1952. 50X1
50X1
 high-level bacteriological defense planning was being carried on, involving the appraisal and evaluation of internal defense capabilities. 487/

Fire defense forces are reported to be efficient. 488/ Fire-fighting instruction is included in the civil defense training of factory workers and block organizations. 489/ Clearing of attics and the placement of fire extinguishers, sand, and shovels have been reported. 490/ Provision for static water supplies, useful in war-time fire fighting, has already been noted. 491/

Elementary blackout and camouflage instruction is apparently included in civil defense courses. 492/ Blackout instructions for 1 city and for 1 factory have been reported, 493/ as has one instance of the appearance of camouflage paint. 494/

* For a photograph of a bunker-type air-raid shelter in Constanta, see Figure 24, following p. 78.



50X1

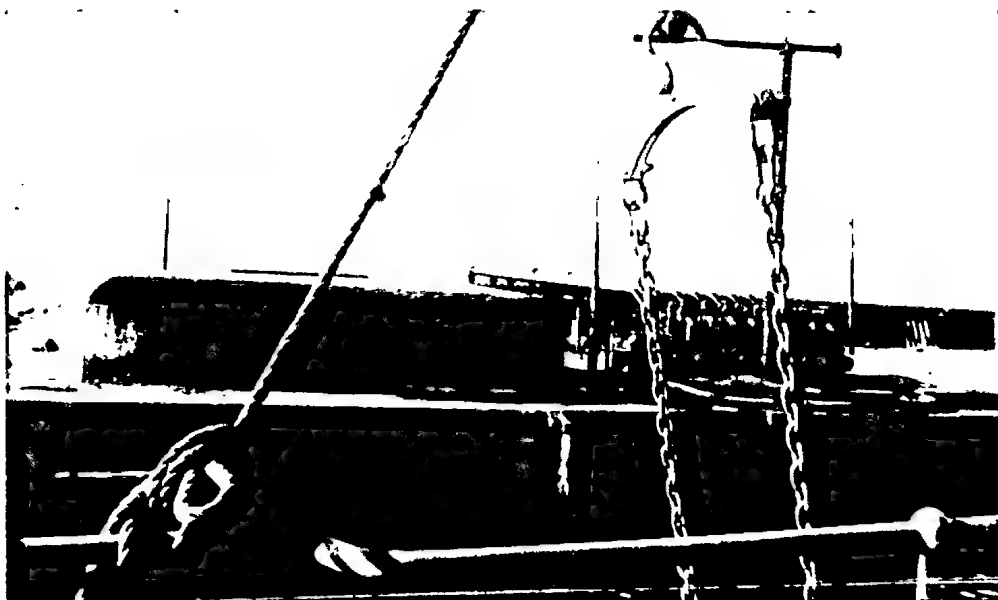

Figure 24
BUNKER-TYPE AIR-RAID SHELTER
Constanta, Rumania

24360 I



50X1

S-E-C-R-E-T

Although the public has been made aware of the possibility of atomic warfare, 495/ atomic defense training for civilians has been largely unreported. Troops have been given some atomic defense training. 496/

It is expected that efforts will be made to continue the development of civil defense along Soviet lines and that atomic civil defense instruction will be instituted. Propaganda regarding the war-like intentions of the West, description of the dangers of atomic attack, and actual compulsion will probably be used to enforce public participation in the program.

X. Possible Action to Retain Control Under Air Attack.

It is relevant to examine courses of action which the USSR might use to minimize casualties and avoid loss of control under nuclear attack. The USSR exploits at least our open literature on the effects of nuclear weapons 497/ and, it must be presumed, is familiar with the published information as to bomb size (up to 15 million tons), radius of destruction (4 miles), "fallout" danger, and other data regarding the effects of nuclear weapons. To assume that the USSR has not considered the advisability of some evacuation in the light of current civil defense thinking and publicity would be dismissing Soviet defense officials as totally incompetent.

Soviet military leaders have published articles toying with the idea that surprise may be the decisive factor in nuclear warfare. 498/ If the USSR reached a decision to commence hostilities against the US using surprise nuclear attack as the initial weapon, Soviet defense authorities could modify their civil defense practices using presently available organizations. Before deliberate attack they would undoubtedly review all defenses in full expectation of massive retaliation. The capabilities of Soviet defenses would be reevaluated in the light of the most recent damage information, and the authorities would attempt to take measures to insure continuing control while guarding against loss of the element of surprise. Possible measures would be limited in part by the present control structure, current practices, and material on hand. (It may be stated here that the MVD probably has a mobilization section 499/ for war planning and that GUMPVO is charged with civil defense planning.)

- 79 -

S-E-C-R-E-T

S-E-C-R-E-T

In view of the above assumptions and the currently discernible aspects of control and civil defense, the adoption of a relatively simple plan might save large elements of the control structure. The alternatives to such a plan would be attempting total evacuation or taking no action at all. Total evacuation is not considered probable, because of the lack of observed activity in this field and the chaos that might result from attempting such a measure without involved preparations and practice. Absolute inaction would be unrealistic and is possibly a dangerous underestimation.

A. Suggested Modified Plan.

If a modified plan of civil defense were chosen, the following course of action might be taken:

1. Before D Day* (Possibly Two Weeks).

Renew or issue sealed mobilization orders to implement the plan. (These orders would be opened and acted upon when a "threatening situation" was announced.) Pressure could be increased on Party, Komsomol, trade union, and government personnel to participate actively in the DOSAAF organization and civil defense training. This has, in fact, been occurring. 500/ Stockpiles of food, construction material, fuel, and the like in dispersed depots could be slightly increased by holding urban stocks to a minimum level.

2. Shortly Before Attack (H Hour** Minus 8).

Move some of the following bodies up to 20 miles outside urban areas under cover of maneuvers, training, or routine checking exercises:

- a. The armed forces.
- b. MVD troops not currently engaged in duties necessitating their presence in cities.
- c. Reserve hospital units, particularly those having personnel situated in central urban areas.

* Date of initiation of attack by the USSR.

** Hour of takeoff for Soviet strategic bombers.

S-E-C-R-E-T

Dispersal of earth-moving and heavy construction equipment from dangerous target areas might be started at this time.

3. Upon Release of Soviet Attack (D Day, H Hour).

a. Declare a "threatening situation" and mobilization based on this plan.

b. Dispatch a small portion (about 20 percent) of Party and government control personnel in each major city to pre-selected safe locations. There they could set up alternate government control centers, outside urban areas.

c. Disperse transport (water, rail, and motor) not in use (or to be used) to a 10- to 20-mile radius.

d. Disperse some Committee on State Security (KGB), Goskontrol, and Gosbank personnel with vital records (presumably near alternate Party-government headquarters).

e. Assemble and remove (by motor) military reserves and remaining troop units not needed for urban control.

f. Alert civil defense forces. Load civil defense equipment on trucks and have loaded trucks stand by at assembly points with additional transport for crews. Set up skeleton civil defense headquarters in protected locations outside potential target areas.

g. Make ready prepared shelters and order population without these to dig hasty types of cover.

4. At Time of "Air Alert" (H Plus 2?).

a. Send those people who are not to be evacuated to shelters, cellars, or prepared trenches. This is in conformance with currently published instructions for behavior under attack.

b. Assemble and move out, by vehicle, services and crews of civil defense except a minimum detachment for maintaining order, and firemen engaged in actual fire fighting. These might move to a distance of 10 miles or more unless prepared shelter or good defilade permitted them to be stationed nearer. Although training for such movement has not yet been reported, the experience of

S-E-C-R-E-T

Germany 501/ and Japan in World War II, 502/ as well as civil defense plans of the US, are consistent in showing that disaster crews and fire equipment should be removed from areas expecting attack in order to avoid losses. 503/

B. Composition of Civil Defense Units.

In addition to the removal from target areas of certain control elements included in the armed forces, security troops, and alternate elements of government, more key personnel might be preserved by assigning them to the air defense crews and services. These services are as follows:

1. Order Crews.

Order crews would probably contain elements of the militia, its auxiliaries, and DOSAAF members. Once the population was placed in shelters, only a small antilooting and control body would be necessary in a city. Self-defense groups of the population have their own order and shelter control bodies, reducing the need for police control.

2. Communications Crews.

Communications crews are organized for operation and repair of communications facilities and would contain many persons who normally work in the communications system. There seems to be no good reason to keep personnel other than a minimum operating group in a likely target area. Repair personnel particularly should be evacuated to a safe distance to be available after attack. Some DOSAAF personnel are trained in telecommunications, 504/ and these probably are also enrolled in communications crews.

3. Repair Crews.

Crews for rescue and repair are probably heavily weighted with personnel assigned from public utilities and construction organizations. There seems to be no valid reason to leave other than minimum operating personnel to undergo attack.

S-E-C-R-E-T

4. Fire-Fighting Crews.

World War II experience proved the advisability of evacuating fire-fighting crews from cities under potential attack, leaving only those units actually engaged in fire fighting within the city.

5. Medical and Veterinary Crews.

The formation and evacuation of civil defense medical crews would give a further opportunity to preserve -- for service -- doctors, nurses, and other medical personnel. It would be advisable to leave in a target area only the minimum number of medical personnel to care for hospitalized persons and emergency cases.

6. Antichemical and Antiatomic Crews.

Antichemical and antiatomic crews would probably contain mostly technicians. Chemists, physicists, and teachers of these subjects probably would be the leaders of reconnaissance and decontamination crews.

7. Plant Disaster Crews.

There appears to be no compelling reason to keep disaster crews of plants or economic enterprises entirely within plants in major target areas. These crews could be divided so that three-fourths or half of a crew would be evacuated from the target area in vehicles, to return immediately after attack or just before the "all clear" announcement. A nucleus of control and maintenance personnel and skilled workers could be preserved by this measure.

Millions of personnel are being trained for civil defense in and by the DOSAAF organizations. It is therefore presumed that these organizations (plus the Red Cross and Red Crescent Societies for first aid) will furnish the chief recruiting ground for civil defense crews and services. DOSAAF members are screened, the entrance requirements being substantially the same as for the Komsomol. 505/ The Party, Komsomol, and trade unions have been constantly urged to support and participate in DOSAAF training. It has been stressed that local air defense crews and services should be made up, using existing local organizations wherever possible. These crews, therefore, will consist of many police, fire-fighting, utility, communications, and medical

S-E-C-R-E-T

personnel whose loyalty, position in the control structure, or skills in repair would be valuable both in maintaining control and in restoring damage.

If this or a similar plan were adopted in the USSR, the following groups would be left to take their chances in cellars or other shelters in large cities: (1) the majority of the population, (2) a minimum level of control personnel, (3) prisoners (in urban jails), (4) hospital patients, (5) older people and the unfit, and (6) unreliaables.

C. Advantages of the Suggested Plan.

This or some similar plan has obvious advantages which could lead to its consideration by Soviet defense planners. These advantages are as follows:

1. There is a minimum chance of loss of the element of surprise, since no substantial action occurs until shortly before an attack by the USSR is initiated.

2. Armed forces and unassigned MVD troops can be removed from target areas to a safe place. From there they would be available for rescue and control if the city were attacked.

3. Establishment of field hospitals could be initiated before attack by military and reserve units.

4. Some transport would be saved by dispersal or by use in moving troops and air defense personnel to peripheral areas.

5. Loss of life, although large, would be selective as to skills and reliability, ensuring continued control and some ability in reconstruction and repair.

6. Control needs would be minimized during the air alert by placing the general population in shelters. The average citizen is instructed and may be convinced that this is the best defense.

7. The nature of civil defense crews (including medical, repair, rescue, fire, communications, and the like) can be rationalized to the general population. The movement of troops and.

S-E-C-R-E-T

reserves would be a normal thing in wartime. The holding of mobile civil defense crews in the area until an actual air alert and returning them immediately after or even before the "all clear" would avoid giving the impression that the general population was being abandoned.

- 85 -

S-E-C-R-E-T

S-E-C-R-E-T

APPENDIX A

CHRONOLOGY OF SOME CIVIL DEFENSE DEVELOPMENTS IN THE USSR
1948-56

<u>Activity Detected</u>	<u>Year of Detection</u>
Self-defense leaders reported in training	1948
Plan reported to train 4 million to 5 million persons per year in civil defense	1948
Training initiated in some ob"yekty	1949
Sanitary epidemiological service reorganized	1949
Decision ordering "basic" radiofication of USSR	1949
Probable initiation of shelter construction program	1949
Call for "tens of thousands" of instructors	1950
Paramilitary bodies merged into DOSAAF	1951
PVKhO study circles made compulsory in DOSAAF units	1952
Apartment managers reported in training	1952
XIXth Party Congress calls for "all-out" defense measures	1952
Civil defense manuals published	1951-52
Civilian gas mask GP-4 probably in production	1952
PVKhO training made mandatory for DOSAAF members	1953
New chairman appointed for DOSAAF (Antiaircraft General)	1953
Publication of nuclear information begun	1954
New DOSAAF manual mentions nuclear weapons	1954
Priority announced to give PVKhO training to all the population	1954
Nuclear tests connected with defense research	1954-55
New commander of DOSAAF recruits demobilized reserves for aid	1955
Soviet leaders call for improved, reorganized antiatomic civil defense	1956
New manuals include instruction in atomic and bacteriological defense	1956
Civilian gas mask GP-4u identified	1956

- 87 -

S-E-C-R-E-T

Page Denied

Next 24 Page(s) In Document Denied

SECRET



50X1



SECRET

50X1